



- 6 7 (& : \$ 7 5 , \$ &

5 H Y \$

^ Z / W d / K E W

7 K H - 6 7 (& : W U X L D W F D E V D W I R U J H Q H U D O S X U S R V H
\$ & V Z L W F K L Q J , W F D Q E H X V H G D V D Q 2 1 2)) I X Q F W L R Q L Q
D S S O L F D W L R Q V V H F X O D D W K R Q W L Q G X F W L R Q P R W R U
V W D U W L Q J F L U F R Q W W V R I Q R U S H K U D D W L R Q
G L P P H U V P R W R U V S H H G F R Q W U R O O H
V Q X E E H U O H V V W O O D E H L F R I P V S H O F L H D G I F
L Q G X F W L Y H O R D G V 3 D F N D J H 7 2 L

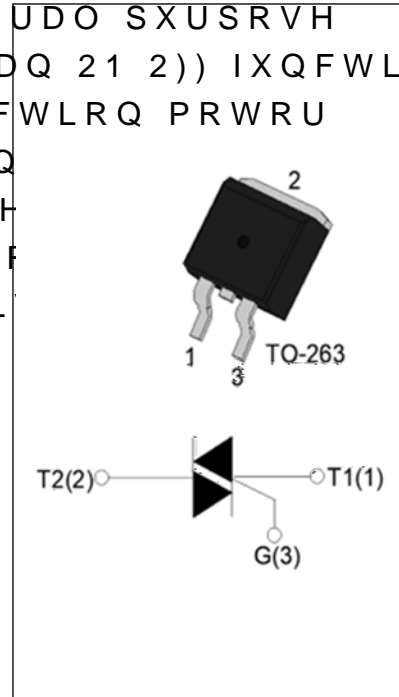

D / E & d h Z ^

6 \ P E R O	9 D O X H	8 Q L W
, 7 5 0 6		\$
9 5 0 \$ 5 0		9
, * 7		P \$

^ K > h d D y / D h D Z d / E ' ^

3 D U D P H W H U	6 \ P E R O	9 D O X H	8 Q L
6 W R U D J H M X Q F W L R Q W H P S H U D W X U H U D Q J H			
2 S H U D W L Q J W H F O S H U L D R O X U H U D Q J H		7	
5 H S H W L W L Y H S H D N R M I V W D W H 0 Y R O W D J H		7	9
5 H S H W L W L Y H S H D N W H Y H U V H 9 5 6 Y R O W D J H		7	9
5 0 6 R Q V W D W H & O F X U U H Q W	7 , 7 5 0 6		\$
1 R Q U H S H W L W L Y H V X U J H S H D N R Q V W D W H F X U U H Q W			\$
1 R Q U H S H W L W L Y H V X U J H S H D N R Q V W D W H F X U U H Q W	7 6 0		\$
, W Y D O X H I R U P X V L Q J W	, W		\$ V
& U L W L F D O B D W G R W D W H F X U U H Q W	G , G W		\$ V
3 H D N J D W H F X U U H Q W W	, * 0		\$
\$ Y H U D J H J D W H S R Z H U G L V V L 3 5 9 W L R Q	7		:
3 H D N J D W H S R Z H U	3 * 0		:

-67 (& :

 -LH-LH 0LFURHOHFWURQL

3HDN SXOVH YROWDJH 7M QRQ UHSHWLWLYH RII VWDWH), *		
--	--	--

> dZ/ > , Z d Z^d/ XQOHVV RWKHUZLVH VSHFLILHG

6\PERO	7HVW &RQGLWLRQ	4XDGUDQW	9DOXH
,7	9 9 5	0\$;	P\$
9*7		0\$;	9
9*	9 9.50 7M 5/ .	0,1	9
/	,* ;7	0\$;	P\$
,+	,7 P\$	0\$;	P\$
G9 GW	99 *DWH 2SHQ 7	0,1	9 V
G, GW	F G9 GW F 9 V	7 0,1	\$ PV
WQ	,* P\$ \$, P\$ 5, P\$	7 < 3	V
W ₁₁	7M		

^d d/ , Z d Z/^d/ ^

6\PERO	3DUDPHWHU	9DOXH 0\$;	8QLW
970	70 \$, W V	M	
972	7KUHVKROG YROWDJH	7	9
5'	'\QDPLF UHVLVWDQFH	7	P
,50	9 9.50 \$ 9.550	7M	
.550		7M	

d, ZD > Z ^/^d E ^

6\PERO	3DUDPHWHU	9DOXH	8QLW
5WK M	F MXQFWLRQ WR FDVH \$&		:
5WK M	D MXQFWLRQ WR DPELHQW	\$& LQ IUHH DLU	6 FP

-67 (&:

 -LH-LH 0LFURHOHFWURQL

KZ Z/E' /E&KZD d/KE

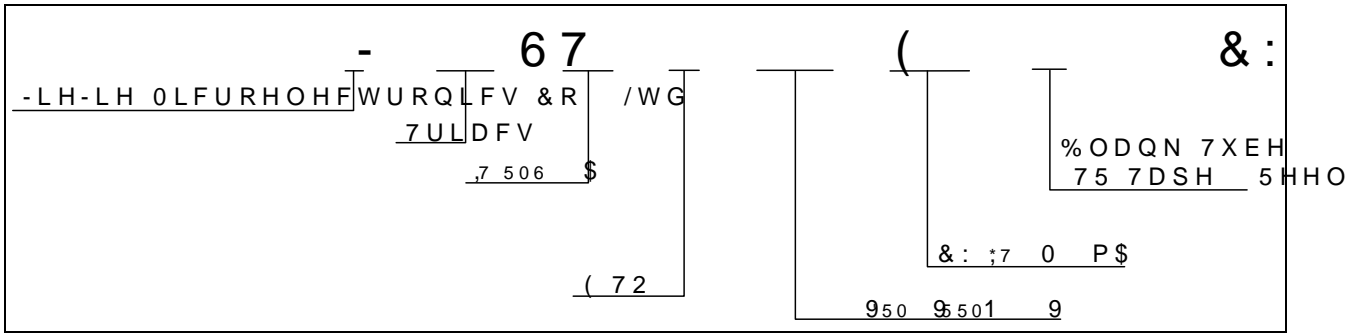

D Z</E'

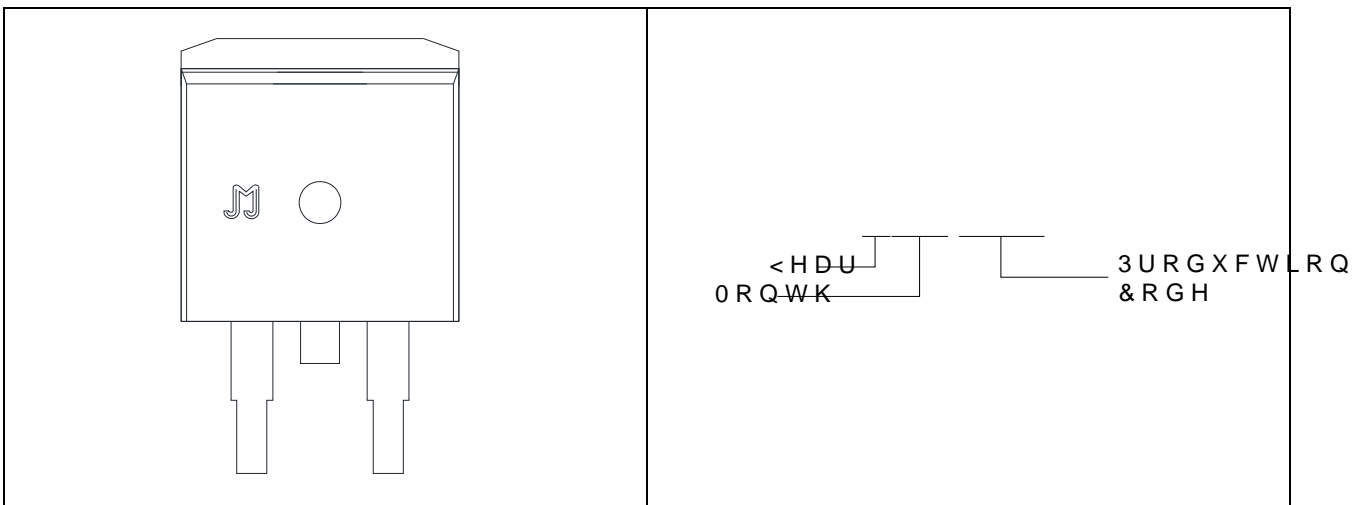

),* 0D[LPXP SRZHU GLVVLSDWLRQ YHUVXU 65RQ VWDWH FXUUHQW YHUVXU WHPSHUDWXUH

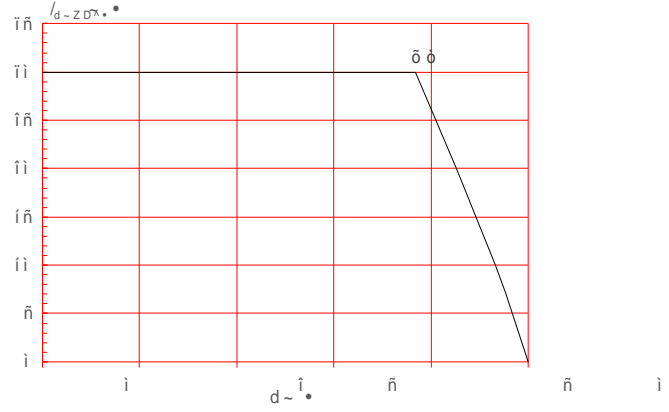
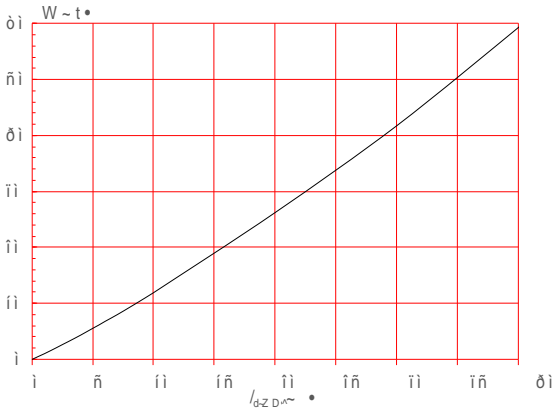

),* 506 RQ VWDWH FXUUHQW YHUVXU 65RQ VWDWH FXUUHQW WHPSHUDWXUH FRSSHUPEHU RI F\FOHV WKLFNQHVV P IXOO F\FOH

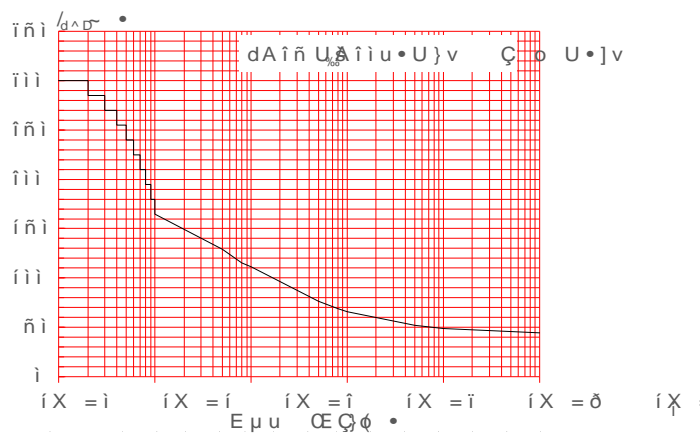
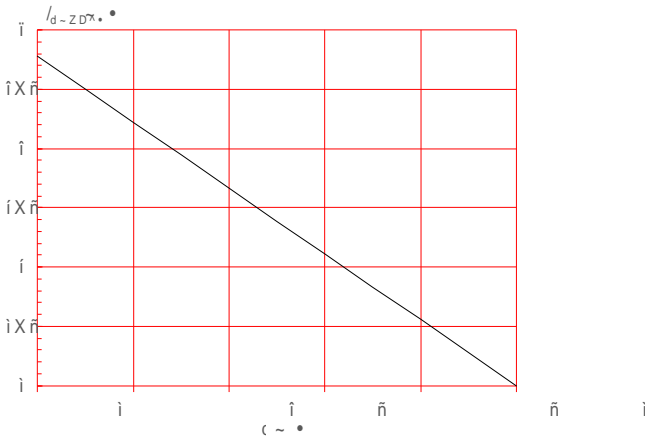

),* 2Q VWDWH FKDUDFWHULVWLFV),* 1RQ UHSHWLWLYH VXUJH SHU RQ VWDWH FXUUHQW IRU D VLQX ZLWK ZSLGRWK WQQ FRUUVSRQGL YDOXHWRIG,, GW \$ V

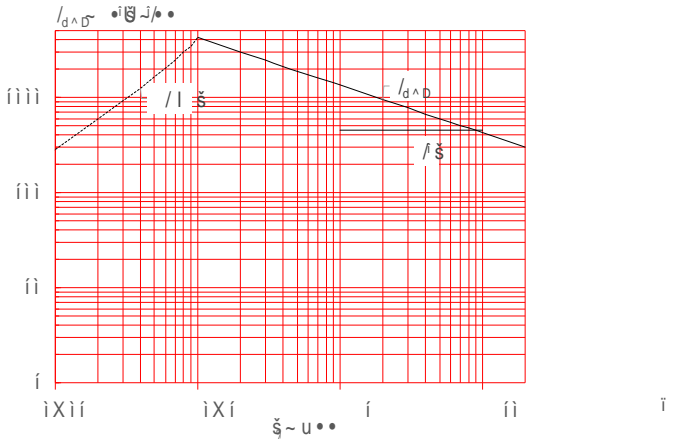
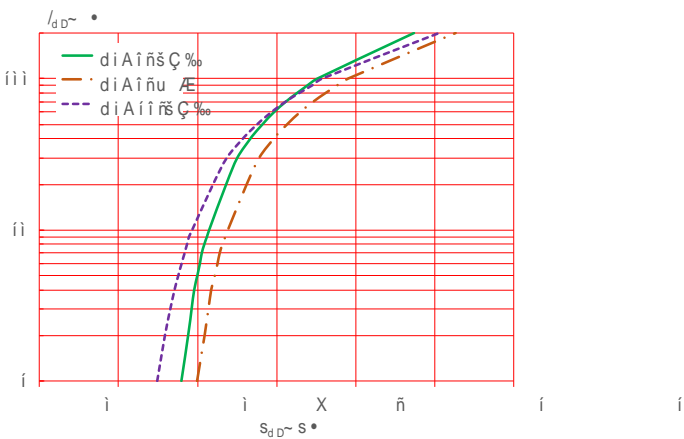

),* Ö7HVW FLUFXLW IRUHQGDUGV WR ,(&
 ,(& 6WDQGDUGV
 6XUJH *HQHUDWRU
 6YROWDJH VXUJH
 6FXUUHQW VXUJH

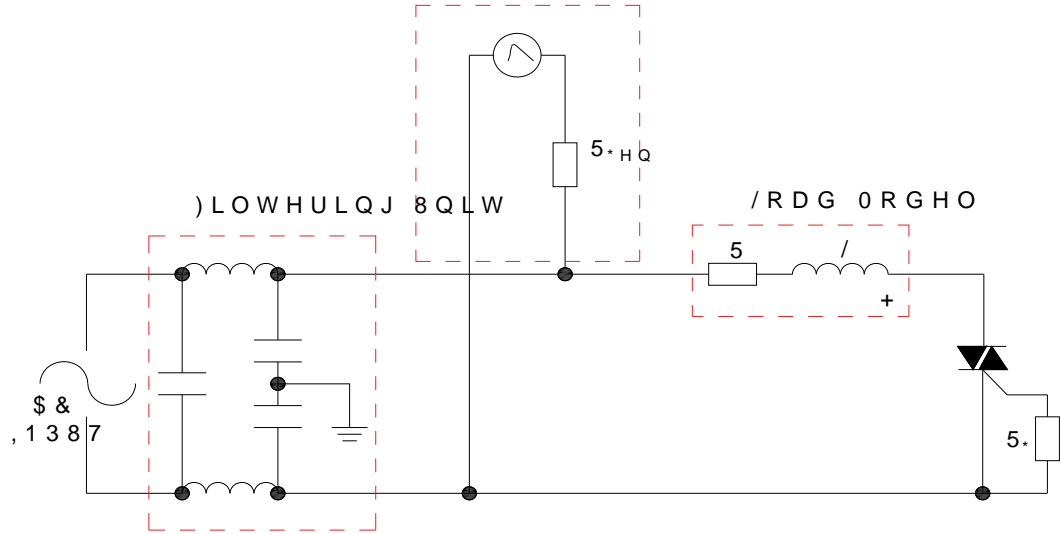

^K> Z/E' W Z D d Z^

5HIOZR &RQGLWLRQ		3E)UHH DVVHPEO\ VHH ILJXUH DW ULJKW
3UH +HDW	7HPSHUDWXUH 0LQ 7 PLQ	
	7HPSHUDWXUH 0D[7 PD[
	7LPH 0LQ WR 0D[WV	
\$YHUDJH UDPS XS UDWH /LTXLGXV 7WRSSHDN		VHF 0D[
7V PD[WR 75DPS XS 5DWH VHF 0D[
5HIOZR /LTXLGXV	7HPSHUDWXUH 7	
	7HPSHUDWXUH W VHFV	
3HDN 7HPS 7		
7LPH ZLWRKLDQFWXDO 3HDN 7HPS W		VHFV
5DPS GRZQ 5DWH		VHF 0D[
7LPH WR 3HDN 7HPS		7PLQ 0D[
'R QRW H[FHHG		

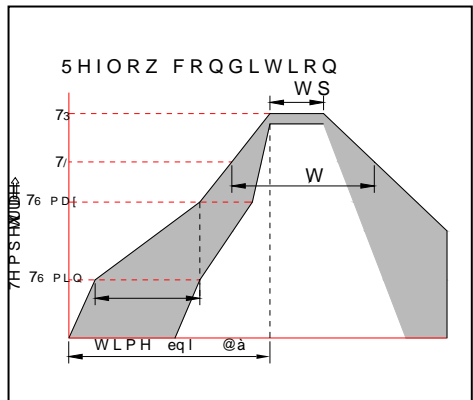

-67 (&:

M-LH-LH 0LFURHOHFWURQL

W < ' D , E/ > d

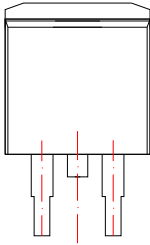
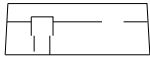

5HI	'LPHQVLRQV					
	0LOOLPHWHUV			,QFKHV		
	0LQ	7\ S	0D[0LQ	7\ S	0D[
\$						
%						
&						
'						
(
)						
*						
+						
-						
.						
/						
0						

>/s Zz DK

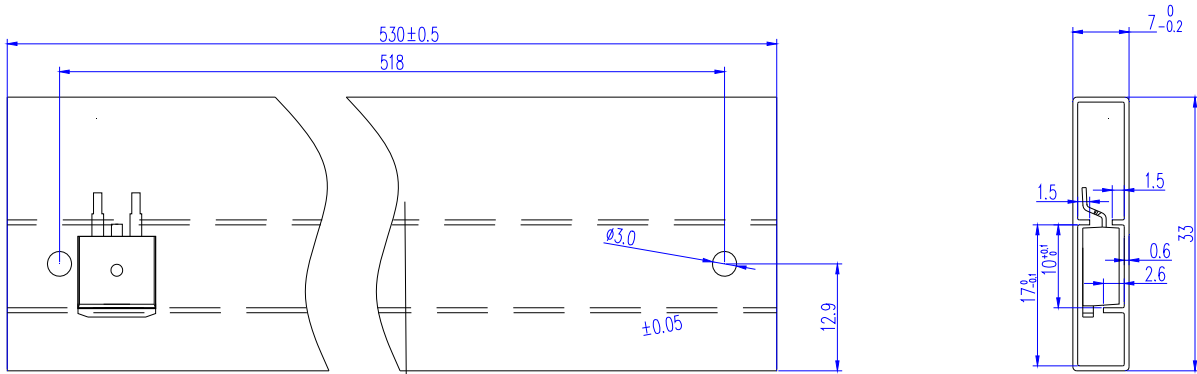

3\$&.\$*(287/,1(78%(3&6	,11(5 %2; 3&6	3(5 &\$572
72	78%(

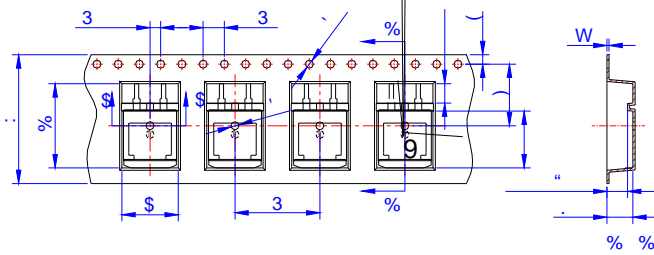

5HI	'LPHQVLRQV					
	0LOOLPHWHUV			,QFKHV		
	0LQ	7\S	0D[0LQ	7\S	0D[
:						
(
)						
'						
'						
3						
3						
3						
\$						
%						
.						
W						

,QIRUPDWLRQ IXUQXFKHQW ILQ WKOLVHGMMB DQGEUHDOLFXELDH +
 -LDQJVVX -LH-LH 0L&URRHOWHFWWRVQLFFVV QR UHVSQRVLELOLW
 FRQVHTXHQFHV RI XGHZDWKRQWRFRQQRKU LQMRLEPHWQBQLW
 ,QIRUPDWLRQ PHQWLRQHG LQ WKLV GRFXPHQW LV VXEMHFF
 WKDW ZKHQ DQ DJUHHLDQQWXL-LV-LJHQFWFKSODJUVHZIPMKW
 3URGXFWV DQG LQIRUPDWLRQ SURYLGHCJHQHOMLVRIGSDFWPH
 -LDQJVVX -LH-LH DVVXPEVOQQW\UIRVSBQM LQWKHOJHPEHIQWVRR I
 SDUWLHV ZKLXFKWPDURPHWKH XVH RI VXJPDVURGXFWLVVDQGFK
 VXSHUVHGHV DQG UHSODFHV DOO LQIRUPDWLRQ SUHYLRXV
 LV D UHJLVWHUHGDQWJDXGLPHDUN QRF-URHOWHFWURQLFV & R
 &RS\ULJKW -LDQJVVX -LH-LHRQLFVR&HFWWG 3WLVQMMNBUSCHG U