



- , (- , (0 , & 5 2 (/ (& 7 5 2 1 , & 6 & 2 / 7

- 6 7 (& : \$ 7 5 , \$ &

5HY \$

^ Z / W d / K E W

7KH - 67 (& : WUXLWFDEW IRU JHQHUDO SXUSRVH \$& VZLWFKLQJ , W FDQ EH XVHG DV DQ 21 2)) IXQFWLRQ LQ DSSOLFDWLRQV VHXODWLRQWLQGXFWLRQ PRWRU VWDUWLQJ FLUFKQWURIRURSHKUDWLRQ GLPPHUV PRWRU VSHHG FRQWUROOH VQXEEHUOHVV WOODJHLFRIPVSHQGLHG IF LQGXFWLYH ORDGV 3DFNDJH 72 L

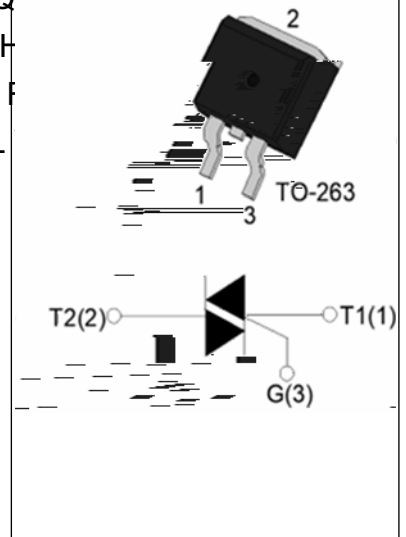

Q W

D / E & dhZ ^

6 \ P E R O	9 D O X H	8 Q L W
, 7 5 0 6		\$
9 5 0 9 5 0		9
, * 7		P \$

^ K > h d D y / D h D Z d / E ' ^

3 D U D P H W H U	6 \ P E R O	9 D O X H	8 Q L
6 W R U D J H M X Q F W L R Q W H P S H U D W X U H U D Q J H			
2 S H U D W L Q J W H P S H U D W X U H U D Q J H		7	
5 H S H W L W L Y H S H D N R M I V W D W H Y R O W D J H		7	9
5 H S H W L W L Y H S H D N W H Y H U V H 9 5 6 R O W D J H		7	9
5 0 6 R Q V W D W H F X U U H Q W	7 , 7 5 0 6		\$
1 R Q U H S H W L W L Y H V X U J H S H D N R Q V W D W H F X U U H Q W			\$
1 R Q U H S H W L W L Y H V X U J H S H D N R Q V W D W H F X U U H Q W			\$
, W Y D O X H I R U P X V L Q J W	, W		\$ V
& U L W L F D O B D W G R W D W H F X U U H Q W	G , G W		\$ V
3 H D N J D W H F X U U H Q W W	, * 0		\$
\$ Y H U D J H J D W H S R Z H U G L V V L S D W L R Q	7		:
3 H D N J D W H S R Z H U	3 * 0		:

-67 (&:

 -LH-LH 0LFURHOHFWURQL

3HDN SXOVH YROWDJH 7M QRQ UHSHWLWLYH RII VWDWH), *	9SS		
--	-----	--	--

> dZ/ > , Z d Z^d/ XQOHVV RWKHUZLVH VSHFLILHG

6\PERO	7HVW &RQGLWLRQ	4XDGUDQW	9DOXH
,7	9 9 5	0\$;	P\$
9*7		0\$;	9
9*	9 9.50 7M 5/ .	0,1	9
/	, ;7	0\$;	P\$
,+	,7 P\$	0\$;	P\$
G9 GW	99 *DWH 2SHQ 7	0,1	9 V
G, GW	F G9 GW F 9 V	7 0,1	\$ PV
WQ	, P\$ \$, P\$ 5, P\$	7 < 3	V
WII	7M		

^d d/ , Z d Z/^d/ ^

6\PERO	3DUDPHWHU	9DOXH 0\$;	8QLW
970	70 \$, W V	7	
972	7KUHVKROG YRQWDJH	7	9
5'	'\QDPLF UHVLVMDQFH	7	P
,50	9 9.50 \$ 9.50	7M	\$
,550		7M	

d, ZD > Z ^/^d E ^

6\PERO	3DUDPHWHU	9DOXH	8QLW
5WK M	FMXQFWLRQ WR FDVH \$&		:

5WK M D MXQFWLRQ WR DPELHQW \$& LQ IUHH DLU 6 ,MFP „,dA

-67 (&:

M-LH-LH 0LFURHOHFWURQL

KZ Z/E' /E&KZD d/KE

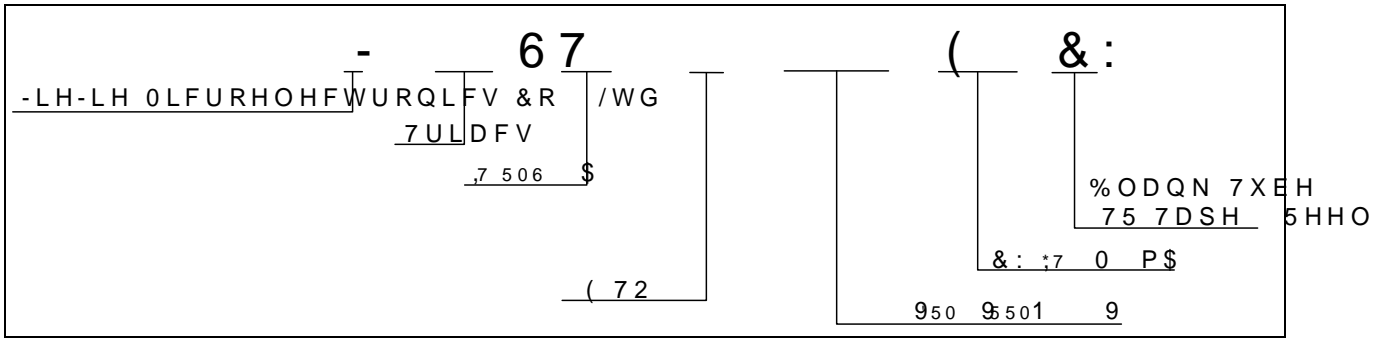

D Z</E'

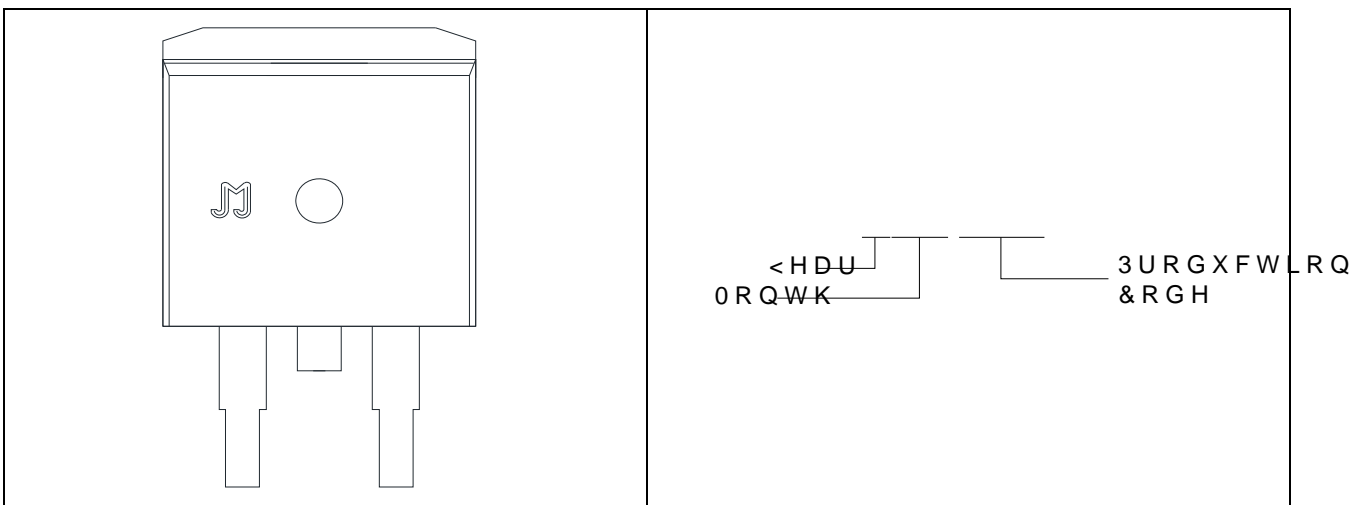

),* 0D[LPXP SRZHU GLVVLSDWLRQ YHUVXU 65RQ VWDWH FXUUHQW YHUVXU WHPSHUDWXUH

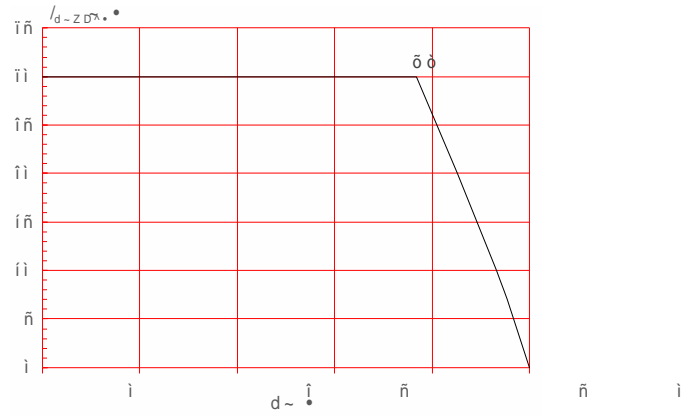
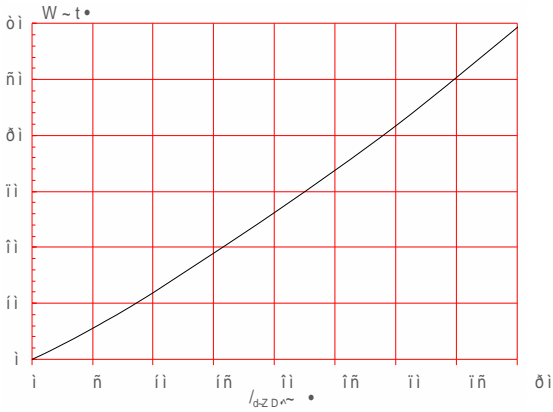

),* 506 RQ VWDWH FXUUHQW YHUVXU 65RQ VWDWH FXUUHQW WHPSHUDWXUH FRSSHUPEHU RI F\FOHV WKLFNQHVV P IXOO F\FOH

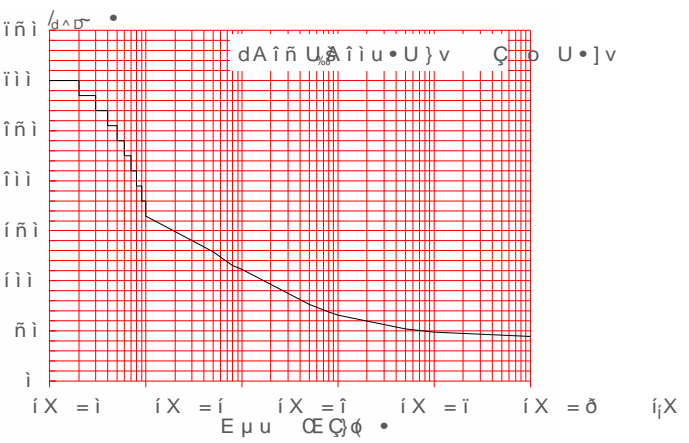
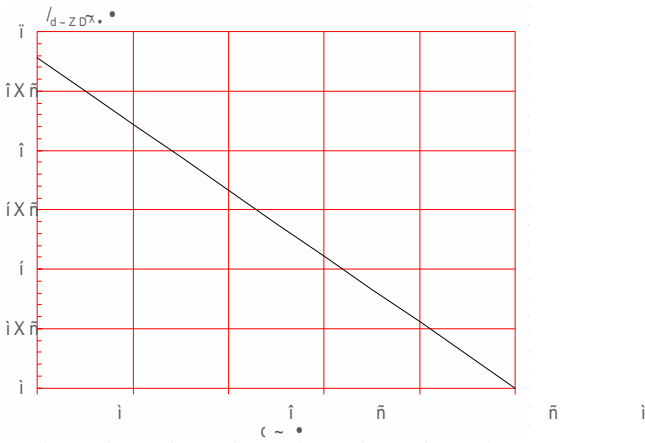

),* 2Q VWDWH FKDUDFWHULVWLFV),* 1RQ UHSHWLWLYH VXUJH SHRQ VWDWH FXUUHQW IRU D VLQX ZLWK ZSLGRWK WQG FRUUVSRQGL YDOXHWRIG,, GW \$ V

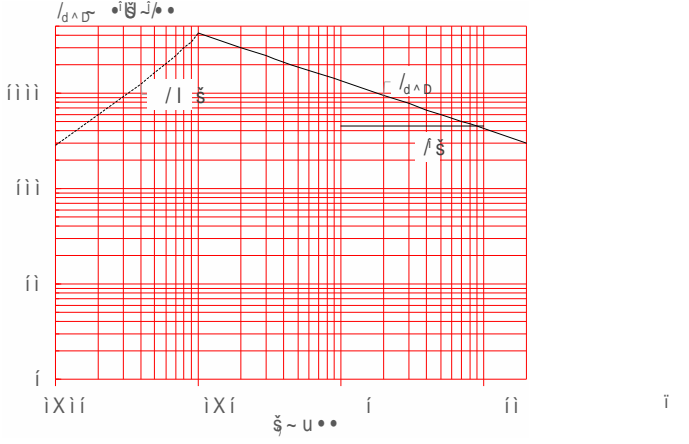
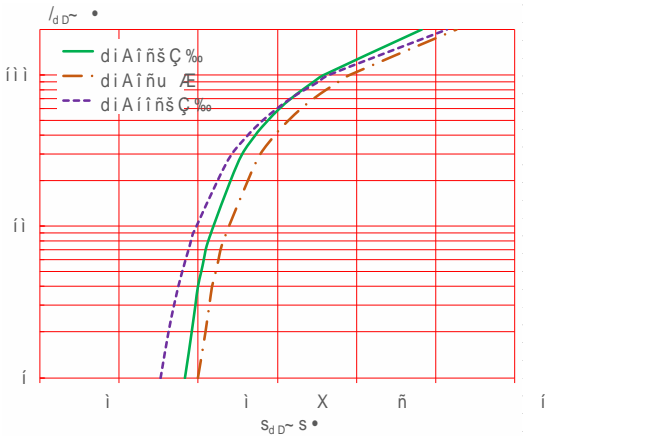

), * 5HODWLYH YDDWDMWMBQJJRU FXUUHQW
KROGLQJ FXUUHQW DQG ODWFKLQJ FXUUHQW YHUVXV
MXQFWLRQ WHPSHUDWXUH

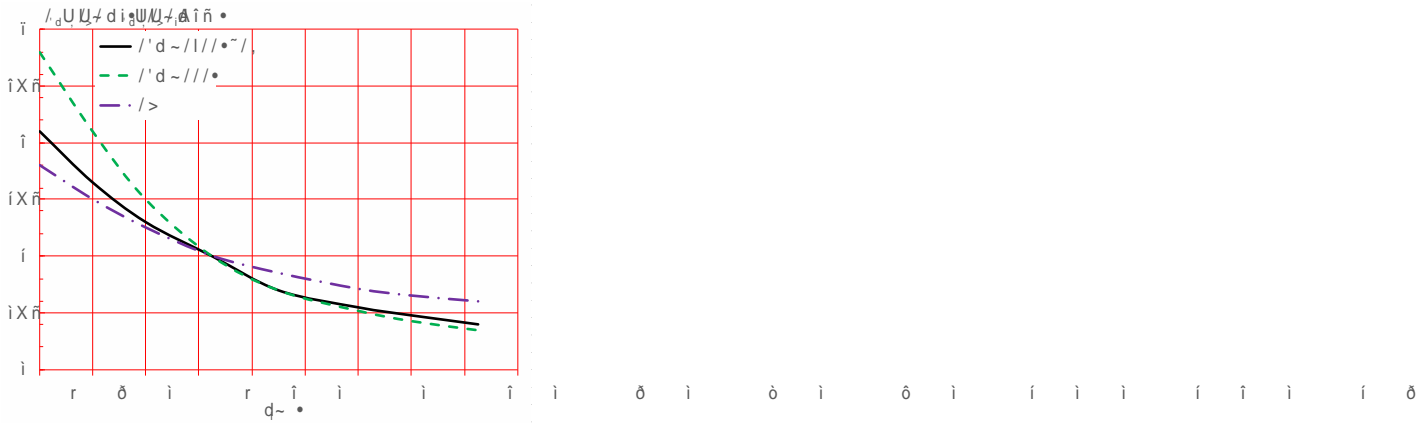

), * Ö7HVW FLUFXLW IRU LQGXFWLYH DQG VMDQGDUGV OF
 , (& 6WDQGDUGV
 6XUJH *HQHUDWRU
 6YROWDJH VXUJH
 6FXUUHQW VXUJH

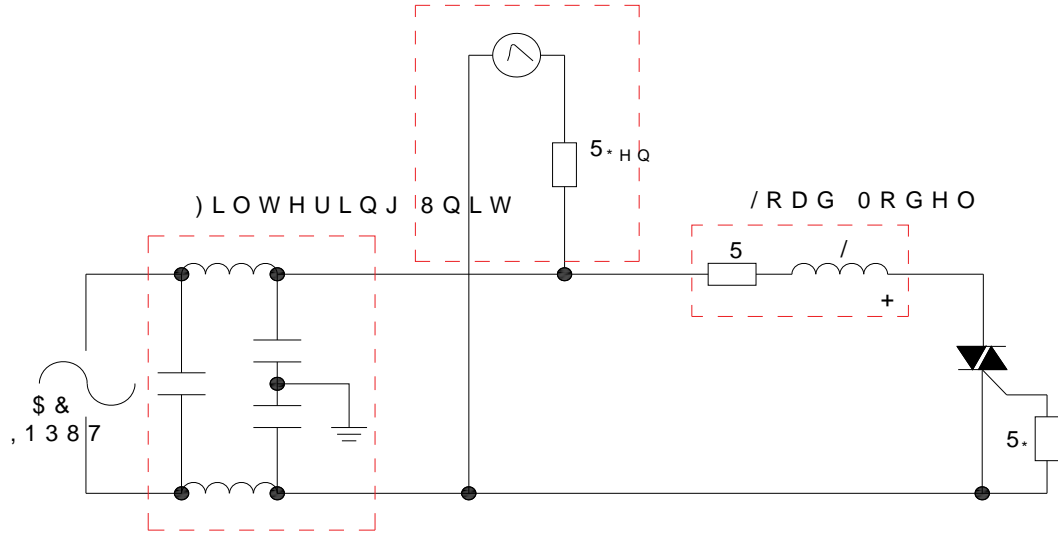

^K> Z/E' W Z D d Z^

5HIOZ &RQGLWLRQ		3E)UHH DVVHPEO\ VHH ILJXUH DW ULJKW
3UH +HDW	7HPSHUDWXUH 0LQ 7 PLQ	
	7HPSHUDWXUH 0D[7 PD[
	7LPH 0LQ WR 0D[WV	
\$YHUDJH UDPS XS UDWH /LTXLGXV 7WRSSHDN		VHF 0D[
7V PD[WR 75DPS XS 5DWH VHF 0D[
5HIOZ /LTXLGXV	7HPSHUDWXUH 7	
	7HPSHUDWXUH W VHFV	
3HDN 7HPS 7		
7LPH ZLWRKLDQFWXDO 3HDN 7HPS W		VHFV
5DPS GRZQ 5DWH		VHF 0D[
7LPH WR 3HDN 7HPS		7PLQ 0D[
'R QRW H[FHHG		

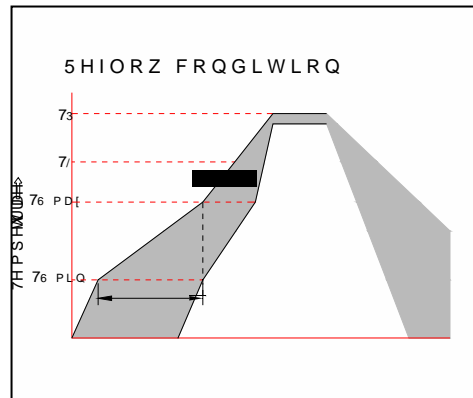

-67 (&:

 -LH-LH 0LFURHOHFWURQL

KZ Z/E' /E&KZD d/KE

2UGHU FRG	9ROWD 9 ₅₀ 9 ₅₀ 9	,*7 P\$ I II III	3DFNDJH	%DVH SFV	'HOLYHU\ PRGH
-67 (&:			72		7XEH
-67 (&: 75					7DSH 5HHO

'RFXPHQW 5HYLVLRQ +LVWRU\

'DWH	5HYLVLRQ	&KDQJHV
\$SU	\$	/DVW XSGDWHG

W < ' D , E / > d

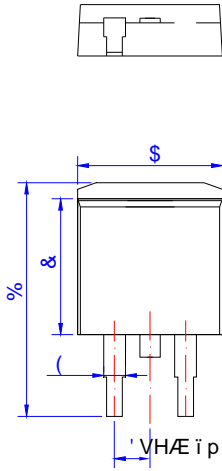

5HI	'LPHQVLRQV					
	0LOOLPHWHUV ,QFKHV					
	0LQ	7\ S	0D[0LQ	7\ S	0D[
\$						
%						
&						
'						
(
)						
*						
+						
-						
/						
0						

VHÆ i p dCEÀñ UACEÀÀ À D@€r #BSuy À À Dp #BT7ey À À Dp #BS5tvÀ À • ` %G`WGI ` #E7WGI ` #E3WQCE

>/s Zz DK

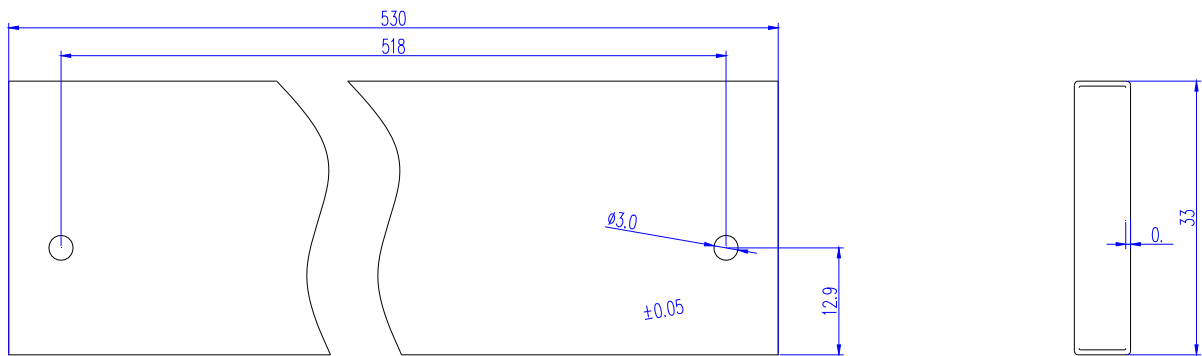

,QIRUPDWLRQ IXUQXFKHQ ILQ WKOLHGYMFB DQGEUHDOLFXEUDH +
 -LDQJVV -LH-LH 0L&URRHOWHGF WDJRQXLFHVV OLRV UHRUS RQKVL ERQVH
 RI XVH ZLWKRXW FRQVLGHUDWLRQ IRG LWFKQLG LRPUDWLRQR Q
 LQ WKLW GRFXPHQW LV VXEMHFW WR FKDDQ HZ KZL Q KROX DJQR
 VLJQH G -LDQJVS OLVHVLZILWRKPKH DJUHHPHQW
 3URGXFWV DQG LQIRUPDWLRQ SURYLGHLG JHQHWLVRG SDXPH
 -LDQJVV -LH-LH DVVXPEVQW\UHRUS DQVI LQWKLHQJHULHQWVRR
 SDUWLHV ZKLFK PD\ UHVXOW IURP WKHPDWLFRQ VXKFKVSGRFG
 VXSHUVHGHV DQG UHSODFHV DOO LQIRUPDWLRQ SUHYLRXV
 LV D UHJLVWHUHGDQJDXGLHDUN RUF-URHOWHGF WURQLFV & R
 &RS\ULJKW -LDQJVV -LH-LHRQLFVR&HFWWG \$OHC ULJKWV UH