



--	--	--	--

ELECTRICAL CHARACTERISTICS



ORDERING INFORMATION

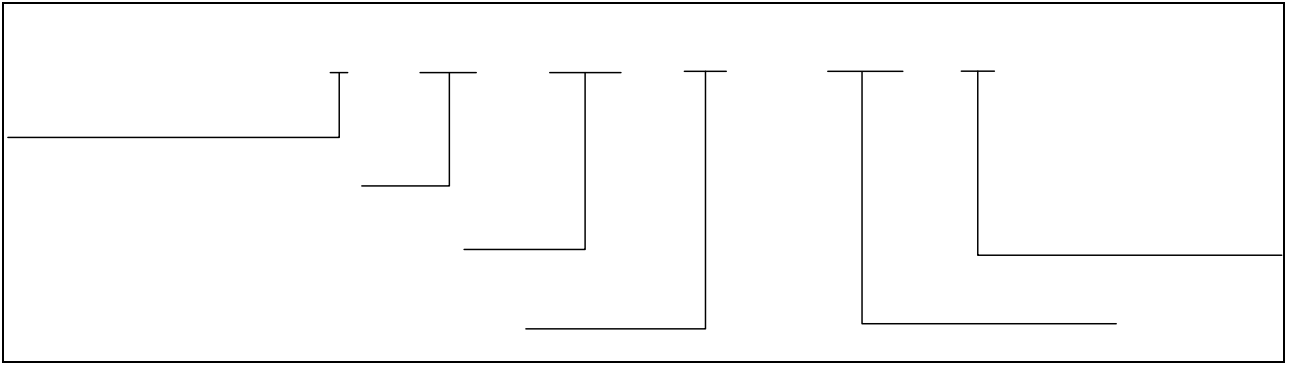

MARKING

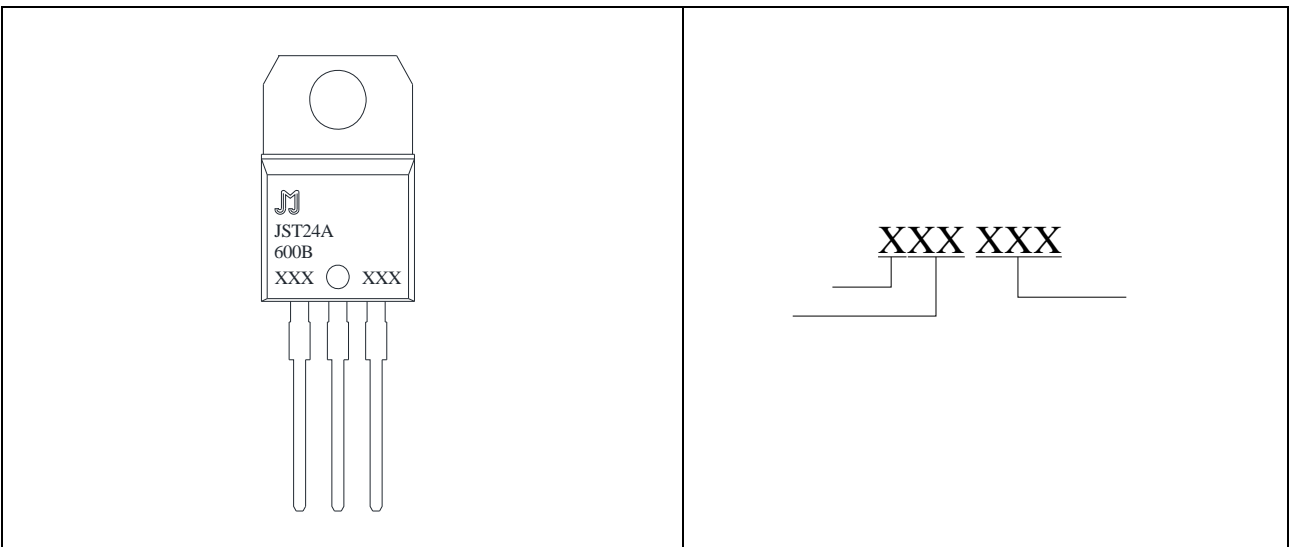

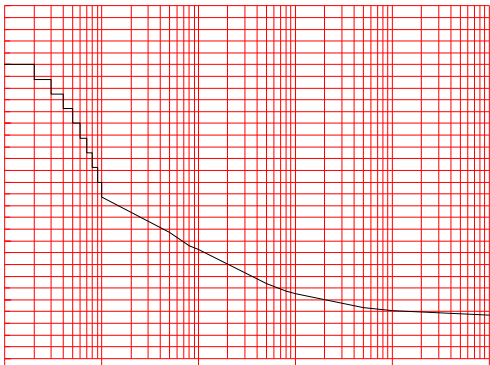
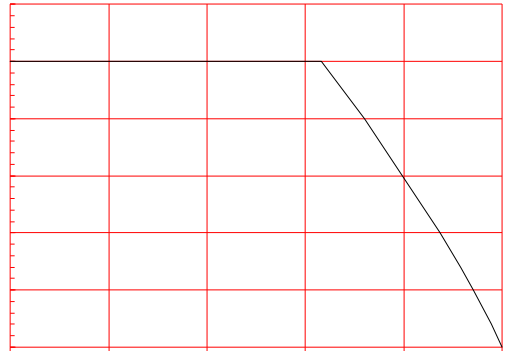
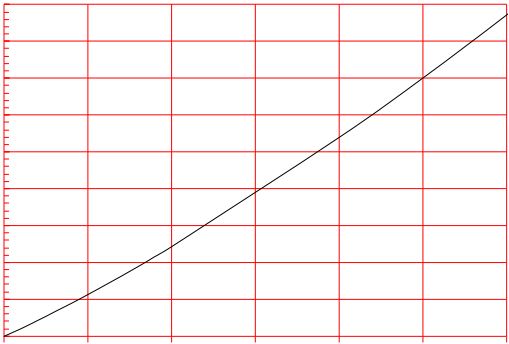

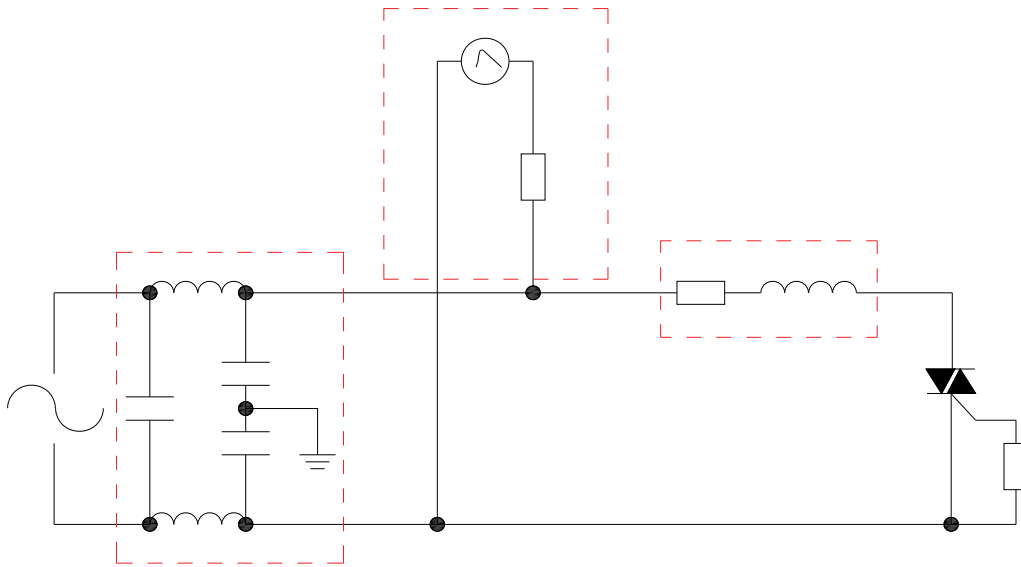

SHAPING AND SOLDERING PARAMETERS



PACKAGE MECHANICAL DATA

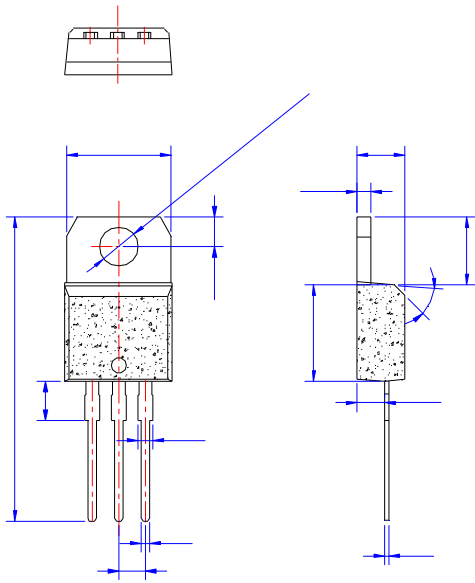

DELIVERY MODE

