



ACJP01W-800SW 1A TRIAC

Rev.A.1.0

DESCRIPTION:

The ACJP01W-800SW triac is suitable for general purpose AC switching. It can be used as an ON/OFF function in applications such as heating regulation, induction motor starting circuits, for phase control operation in light dimmers, motor speed controllers. The ACJP01W-800SW embeds a TVS structure to absorb the inductive turn-off energy such as those described in the IEC 61000-4-5 standards. At the same time, the triac shields the positive signal trigger to reduce the probability of product misoperation. It is triggered with a negative gate current flowing out of the gate pin. Package SOT-223-2L is RoHS compliant.

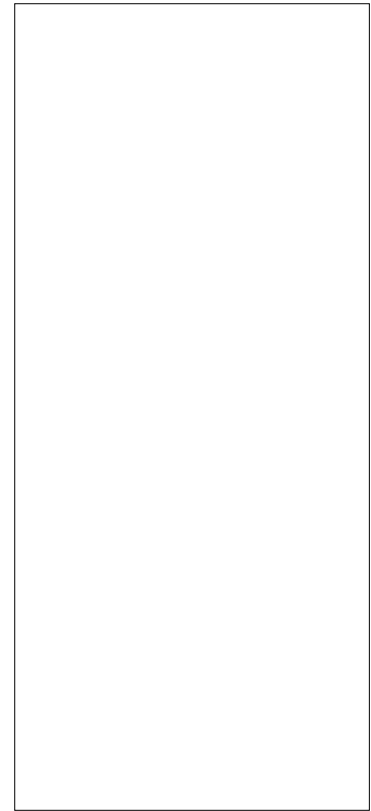

MAIN FEATURES

ABSOLUTE MAXIMUM RATINGS

Parameter	Symbol	Value	Unit
Storage junction temperature range	T_{stg}	-40-150	
Operating junction temperature range	T_j	-40-125	
Repetitive peak off-state voltage ($T_j=25$)	V_{DRM}	800	V
Repetitive peak reverse voltage ($T_j=25$)	V	800 0 Td (V5C 0.004 Tc -0.002 Tw	

Average gate power dissipation ($T_j=125$)	$P_{G(AV)}$	0.1	W
Peak gate power	P_{GM}	2	W
Peak pulse voltage ($T_j=25$; non-repetitive, off-state; FIG.8)	V_{pp}	4.5	kV

ELECTRICAL CHARACTERISTICS ($T_j=25$ unless otherwise specified)

Symbol	Test Condition	Quadrant	Value		Unit
I_{GT}	$V_D=12V$ $R_L=33$	-	MAX.	10	mA
V_{GT}		-	MAX.	1	V
V_{GD}	$V_D=V_{DRM}$ $T_j=125$ $R_L=3.3K$	-	MIN.	0.15	V
I_L	$I_G=1.2I_{GT}$		MAX.	25	mA
				10	
I_H	$I_T=100mA$		MAX.	10	mA
dV/dt	$V_D=540V$ Gate Open $T_j=125$		MIN.	100	V/ μs
$(dI/dt)_c$	$(dV/dt)_c=10V/\mu s$, $T_j=125$		MIN.	0.6	A/ms
t_{on}	$I_G=20mA$ $I_A=200mA$ $I_R=20mA$ $T_j=25$		TYP.	2.5	μs
t_{off}				25	
V_{CL}	$I_{CL}=0.1mA$ $t_p=1ms$		MIN.	900	V

STATIC CHARACTERISTICS

Symbol	Parameter		Value(MAX.)	Unit
V_{TM}	$I_{TM}=1.1A$ $t_p=380\mu s$	$T_j=25$	1.3	V
V_{TO}	Threshold voltage	$T_j=125$	0.77	V
R_D	Dynamic resistance	$T_j=125$	276	m
I_{DRM}	$V_D=V_{DRM}$ $V_R=V_{RRM}$	$T_j=25$	5	μA
I_{RRM}		$T_j=125$	0.4	mA

THERMAL RESISTANCES

Symbol	Parameter	Value	Unit
$R_{th(j-c)}$	junction to case (AC)	25	$^{\circ}W$
$R_{th(j-a)}$	junction to ambient (AC)	150	$^{\circ}W$

ORDERING INFORMATION

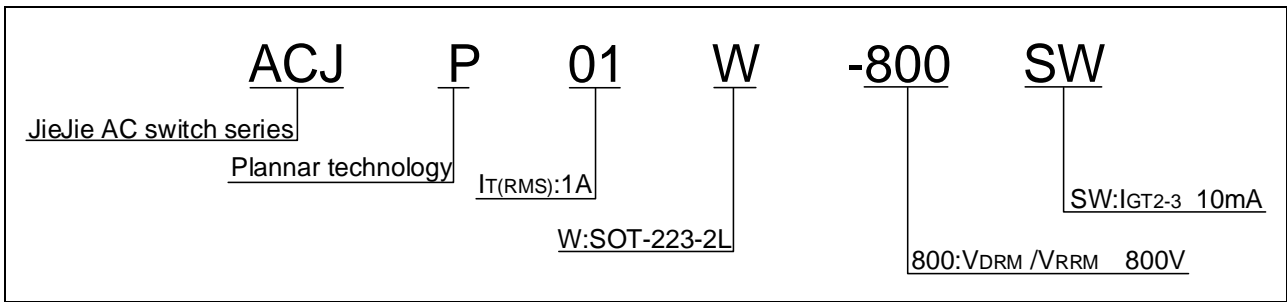

MARKING

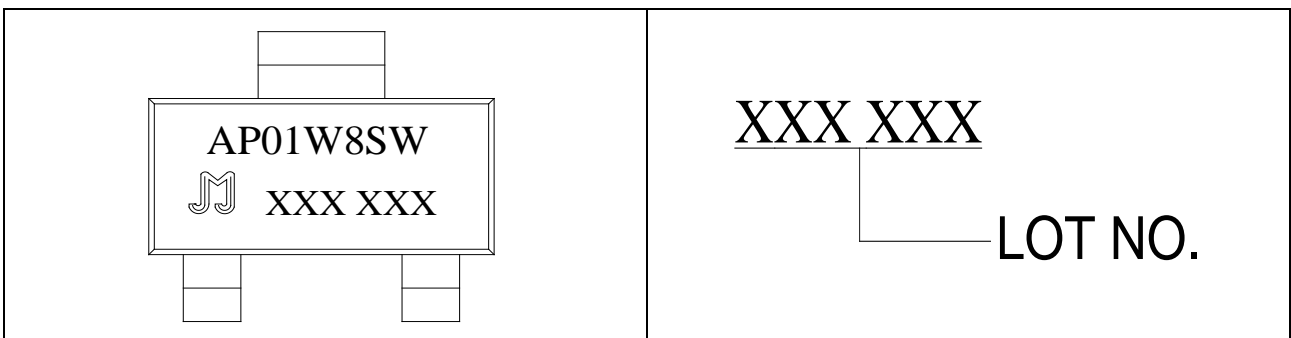

FIG.1 Maximum power dissipation versus RMS on-state current

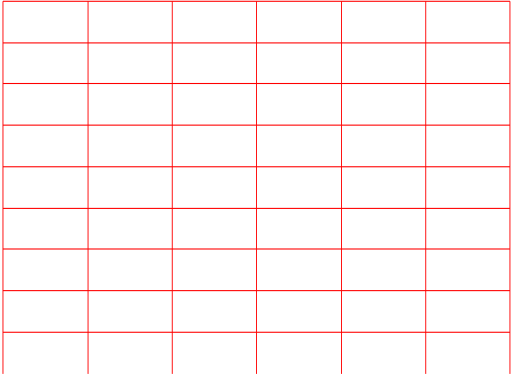

FIG.2: RMS on-state current versus case temperature

FIG.7: Relative variations of gate trigger current, holding current and latching current versus junction temperature

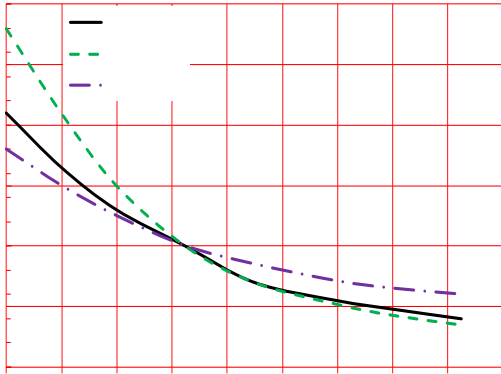
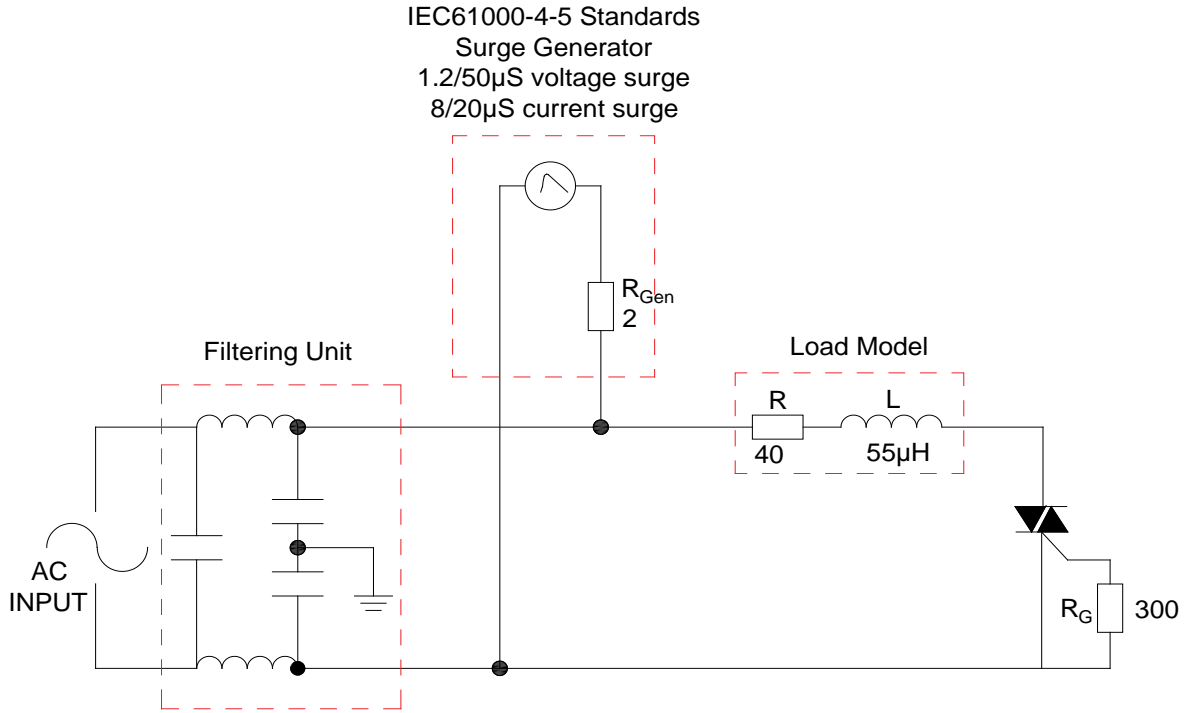

FIG.8 Test circuit for inductive and resistive loads to IEC-61000-4-5 standards



ORDERING INFORMATION

Order code	Voltage V_{DRM}/V_{RRM} (V)	IGT(mA)	Package	Base qty. (pcs)	Delivery mode
ACJP01W-800SW	800	10	SOT-223-2L	4,000	Tape & Reel

Document Revision History

Date	Revision	Changes
Apr.10, 2023	A.1.0	Last updated

PACKAGE MECHANICAL DATA

DELIVERY MODE

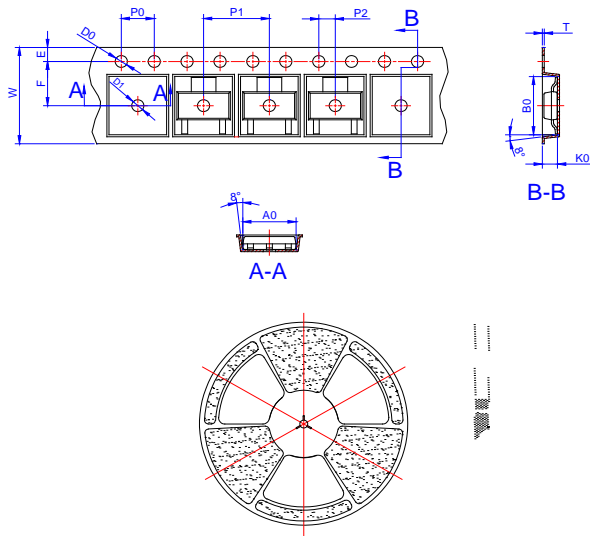

Ref.	Dimensions					
	Millimeters			Inches		
	Min.	Typ.	Max.	Min.	Typ.	Max.
W	-	-	12.30	-	-	0.482
E	1.65	1.75	1.85	0.065	0.069	0.073
F	5.45	5.50	5.55	0.215	0.217	0.219
D0	1.50	1.55	1.60	0.059	0.061	0.063
D1	1.50	-	-	0.059	-	-
P0	3.90	4.00	4.10	0.154	0.157	0.161
P1	7.90	8.00	8.10	0.311	0.315	0.319
P2	1.95	2.00	2.05	0.077	0.079	0.081
10P0	39.80	40.00	40.20	1.567	1.575	1.583
A0	6.85	6.95	7.05	0.269	0.273	0.276
B0	7.15	7.25	7.35	0.280	0.284	0.288
K0	1.95	2.05	2.15	0.076	0.080	0.084
T	0.20	0.25	0.30	0.008	0.010	0.012

