



T3050H-6F 30A TRIAC

Rev.A.1.0

DESCRIPTION:



ELECTRICAL CHARACTERISTICS

Symbol	Test Condition	Quadrant	Value	Unit

STATIC CHARACTERISTICS

Symbol	Parameter	Value(MAX.)	Unit

THERMAL RESISTANCES

Symbol	Parameter	Value	Unit

ORDERING INFORMATION

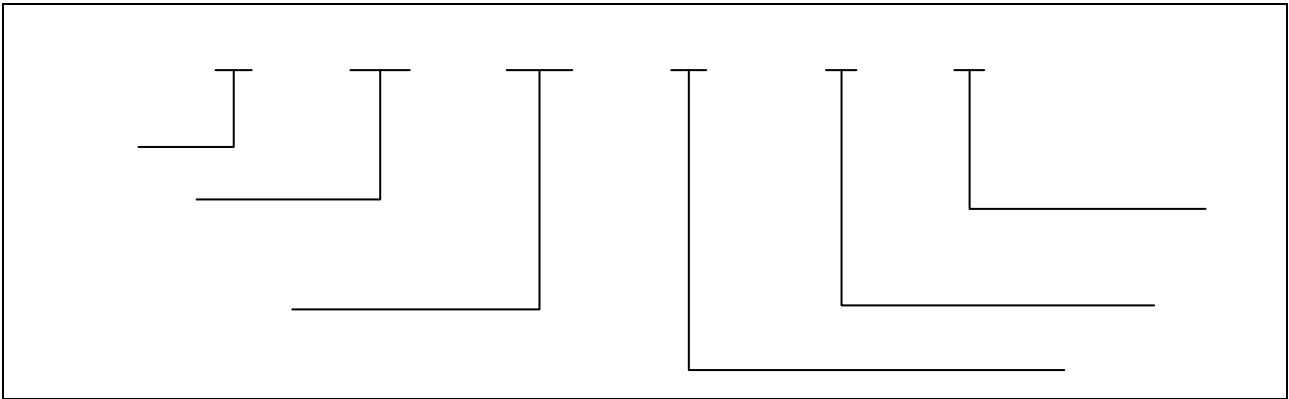

MARKING

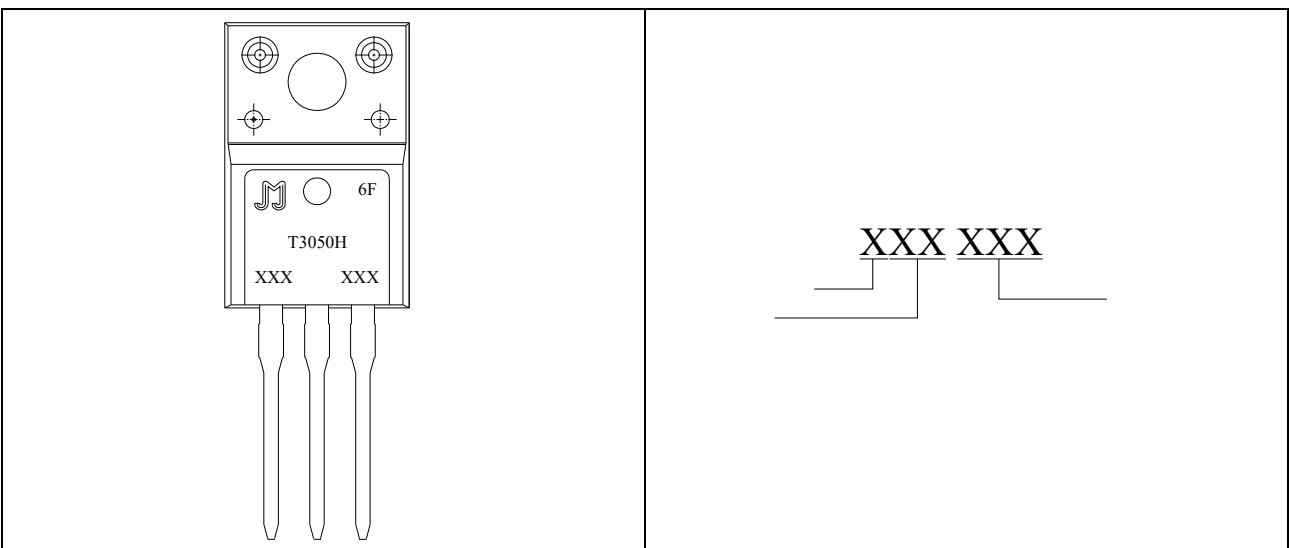

FIG.1

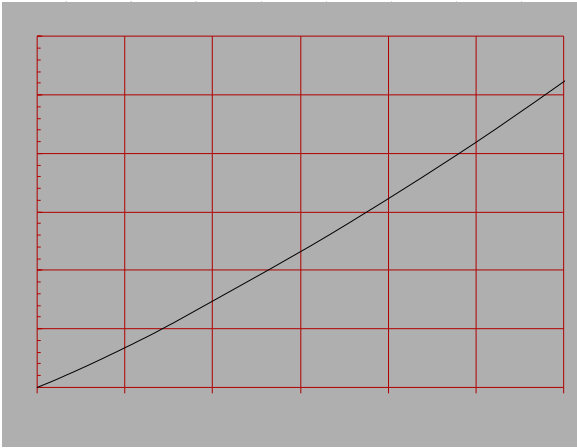

FIG.2:

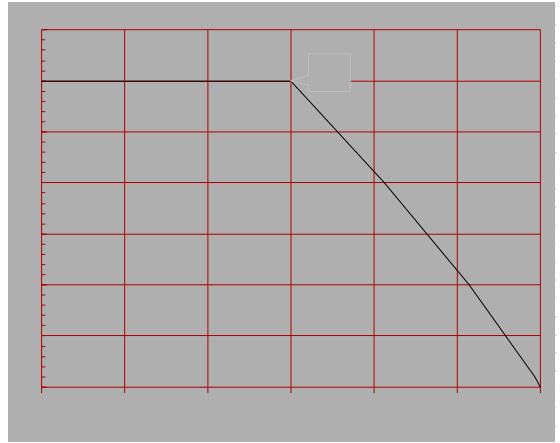

FIG.3:

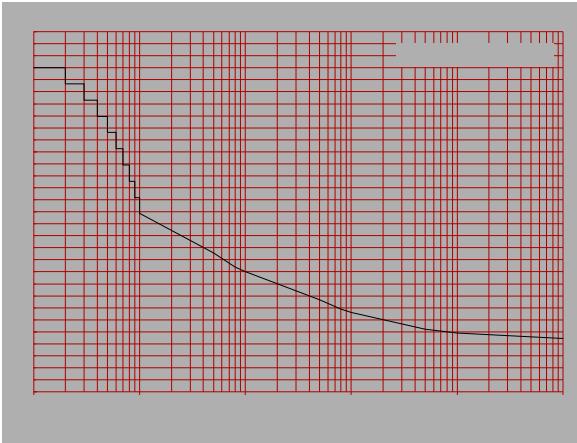
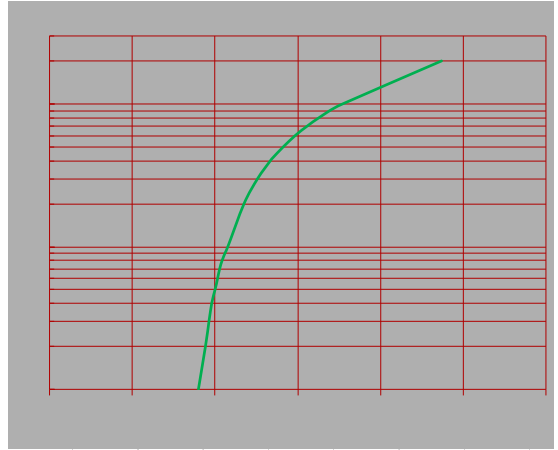
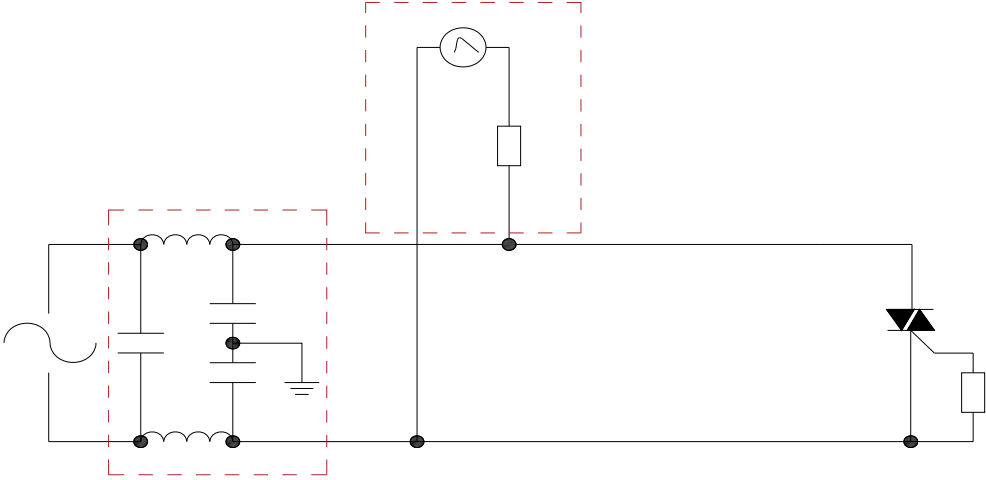

FIG.4:





SHAPING AND SOLDERING PARAMETERS

ORDERING INFORMATION

Order code	Voltage V _{DRM} /V _{RRM} (V)	IGT(mA)	Package	Base qty. (pcs)	Delivery mode
		- -			
T3050H-6F	600	50	TO-220F(Ins)	50	Tube

Document Revision History

Document Revision History		

PACKAGE MECHANICAL DATA

