

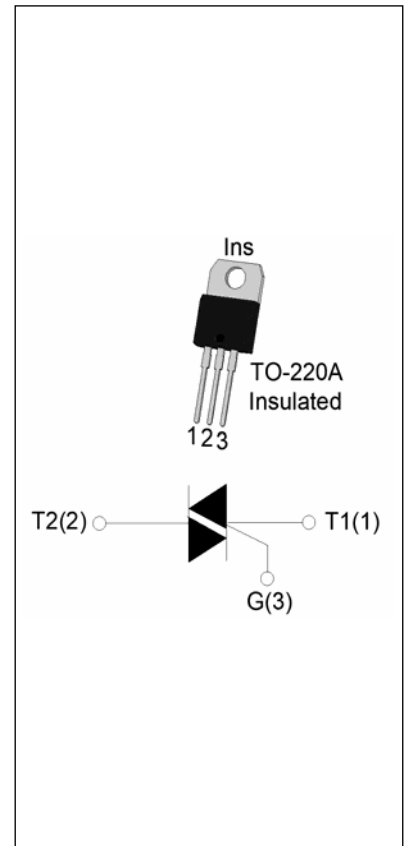

DESCRIPTION:



MAIN FEATURES

I II III		

ABSOLUTE MAXIMUM RATINGS

Parameter	Symbol	Value	Unit
			°C
			°C
			°C
			°C
$\leq$			°C
			°C
			°C
			°C
×			°C
			°C



ORDERING INFORMATION

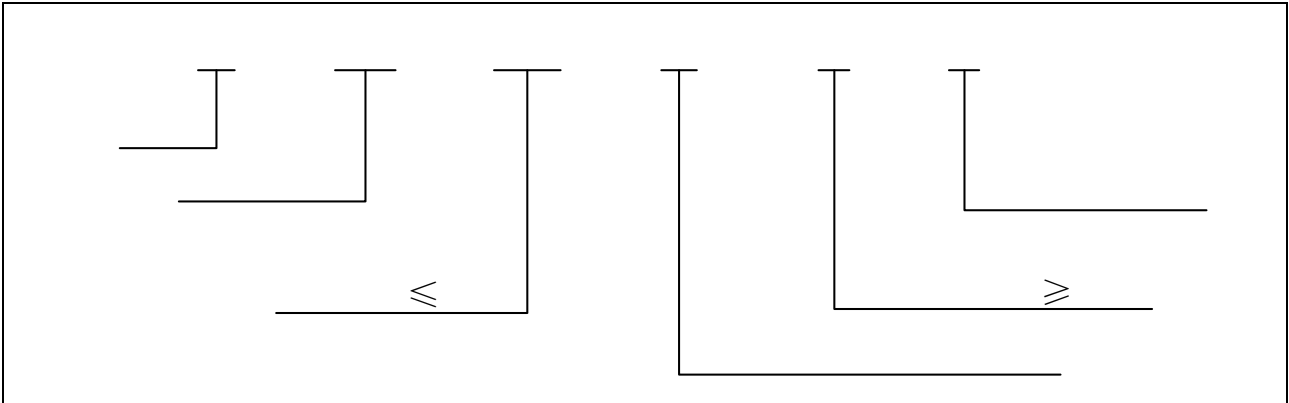

MARKING

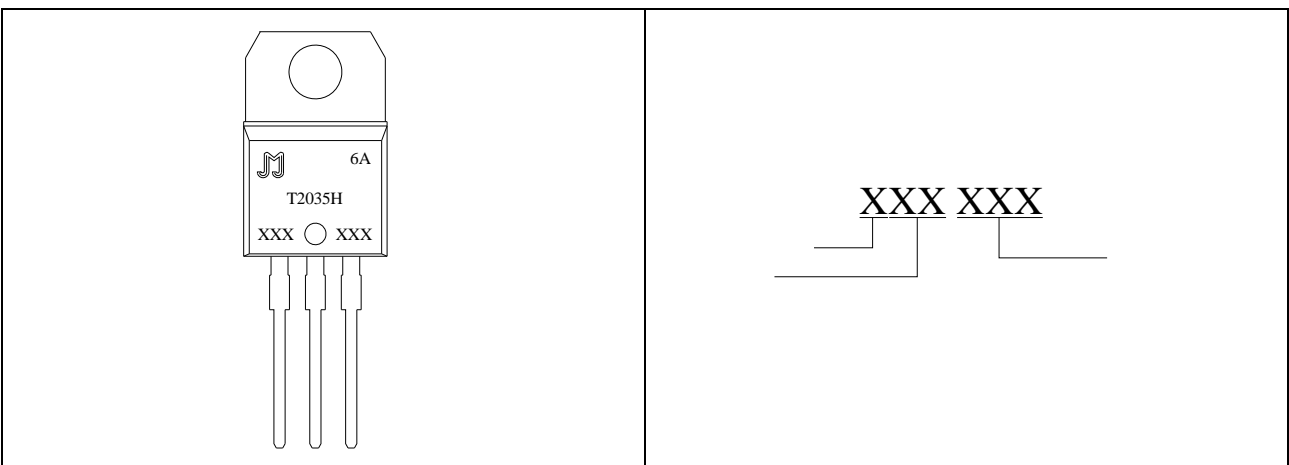

FIG.1

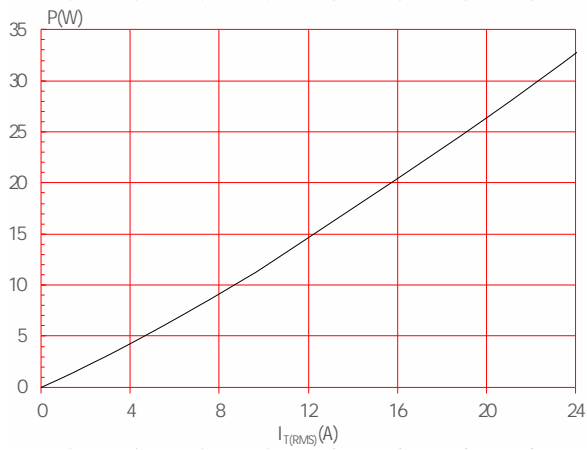

FIG.2:

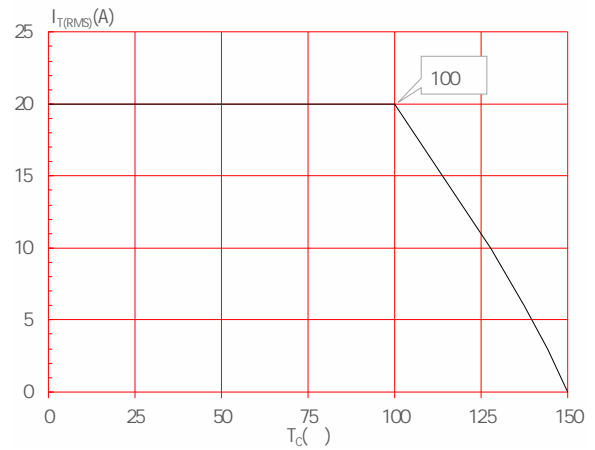

FIG.3:

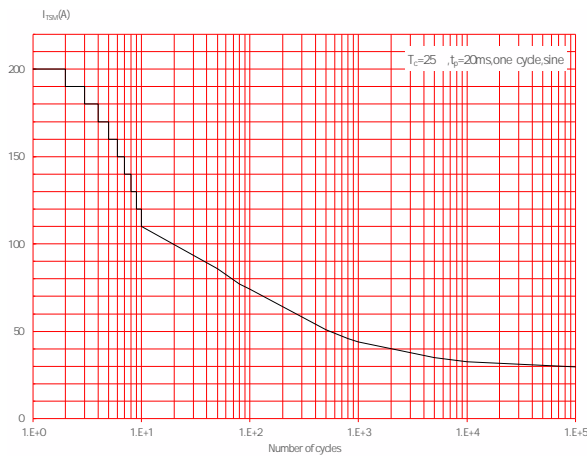

FIG.4:

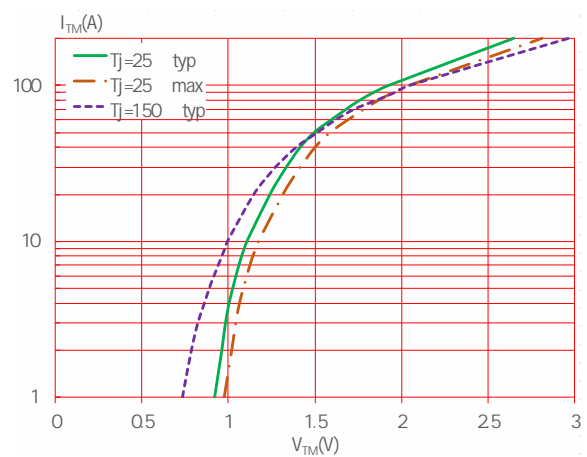

FIG.5:

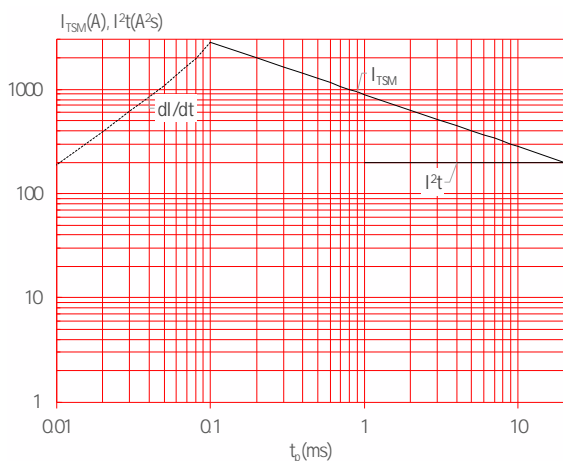
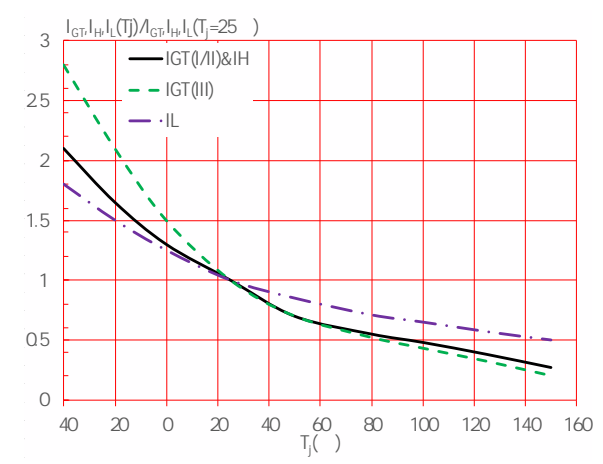
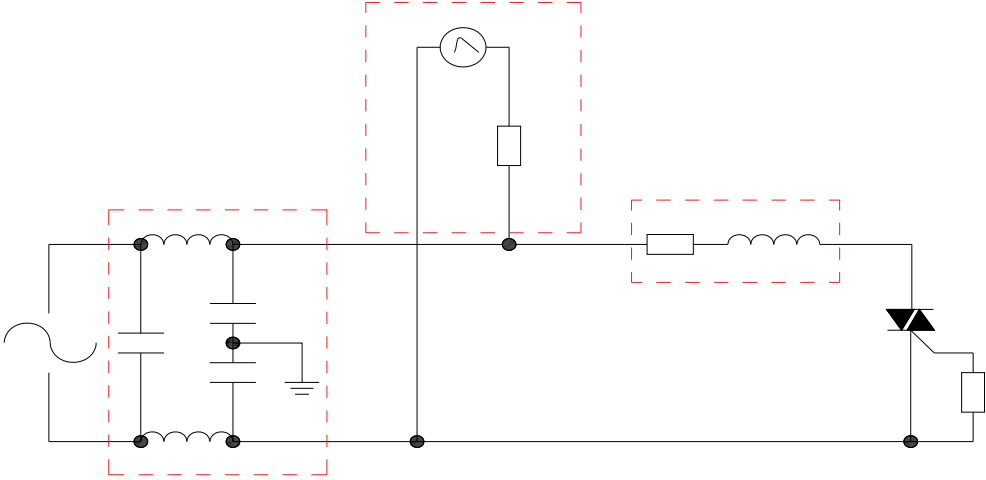

FIG.6:



:



SHAPING AND SOLDERING PARAMETERS

《

》

ORDERING INFORMATION

Order code	Voltage V <sub>DRM</sub> /V <sub>RPM</sub> (V)	IGT(mA)	Package	Base qty. (pcs)	Delivery mode
		- -			
T2035H-6A	600	35	TO-220A(Ins)	50	Tube

Document Revision History

Document Revision History		

PACKAGE MECHANICAL DATA

