



T1250H-8E 12A TRIAC

Rev.A.1.0

DESCRIPTION:

The T1250H-8E triac is suitable for general purpose AC switching. It can be used as an ON/OFF function in

Peak pulse voltage ($T_j=25$; non-repetitive, off-state; FIG.8)	V_{pp}	4.5	kV
--	----------	-----	----

ELECTRICAL CHARACTERISTICS ($T_j=25$ unless otherwise specified)

Symbol	Test Condition	Quadrant	Value		Unit
I_{GT}	$V_D=12V$ $R_L=33$	- -	MAX.	50	mA
V_{GT}		- -	MAX.	1	V
V_{GD}	$V_D=V_{DRM}$ $T_j=150$ $R_L=3.3K$	- -	MIN.	0.2	V
I_L	$I_G=1.2I_{GT}$	-	MAX.	50	mA
				80	
I_H	$I_T=500mA$		MAX.	40	mA
dV/dt	$V_D=540V$ Gate Open $T_j=150$		MIN.	2000	V/ μs
(dI/dt) _c	(dV/dt) _c =20V/ μs , $T_j=150$		MIN.	10	A/ms
t_{on}	$I_G=80mA$ $I_A=400mA$ $I_R=40mA$ $T_j=25$		TYP.	3	μs
t_{off}				70	

STATIC CHARACTERISTICS

Symbol	Parameter		Value(MAX.)	Unit
V_{TM}	$I_{TM}=17A$ $t_p=380\mu s$	$T_j=25$	1.4	V
V_{TO}	Threshold voltage	$T_j=150$	0.75	V
R_D	Dynamic resistance	$T_j=150$	37	m
I_{DRM}	$V_D=V_{DRM}$ $V_R=V_{RRM}$	$T_j=25$	5	μA
I_{RRM}		$T_j=150$	2	mA

THERMAL RESISTANCES

Symbol	Parameter	Value	Unit
$R_{th(j-c)}$	junction to case (AC)	1.3	/W
$R_{th(j-a)}$	junction to ambient (AC, in free air, $S=2cm^2$)	45	/W

ORDERING INFORMATION

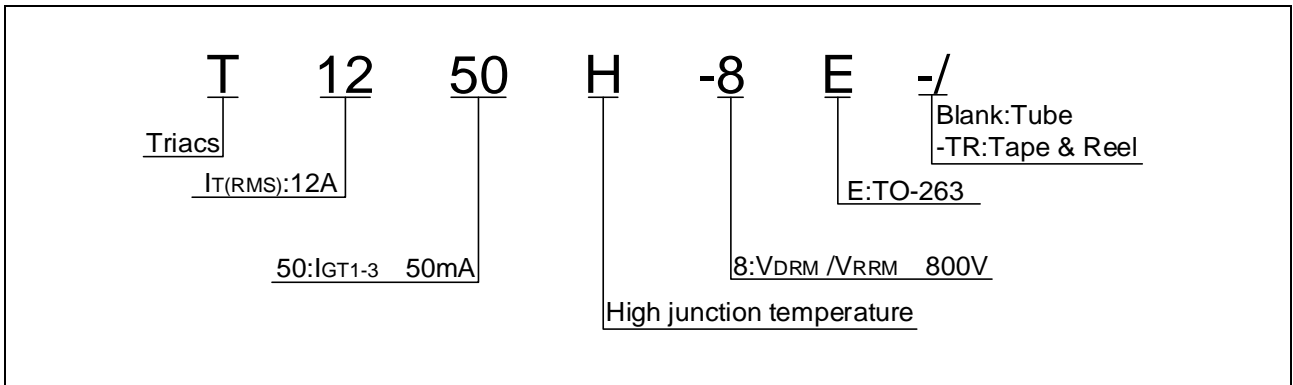

MARKING

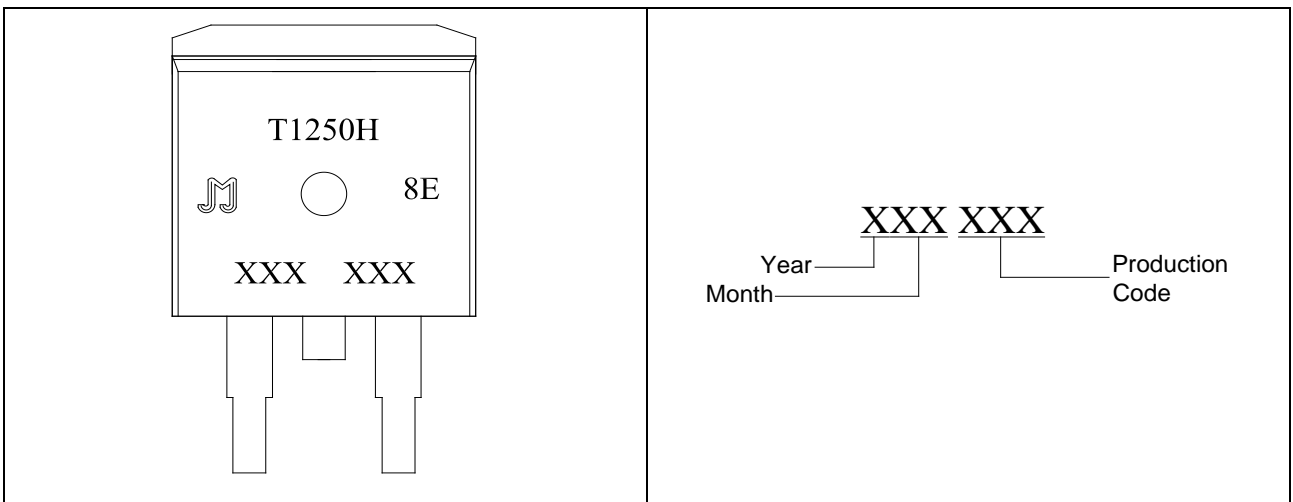

FIG.1 Maximum power dissipation versus RMS on-state current

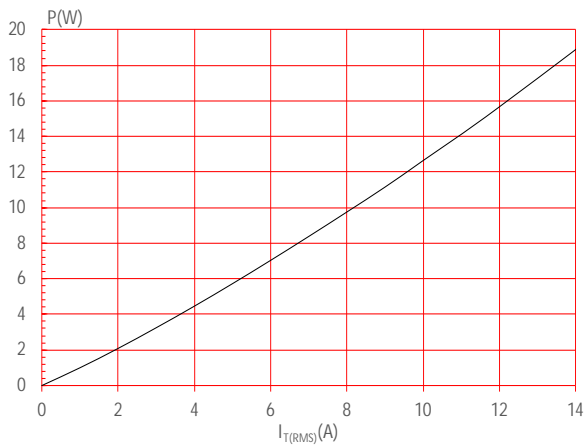

FIG.3: RMS on-state current versus ambient temperature (printed circuit board FR4,copper thickness:35 μ m)(full cycle)

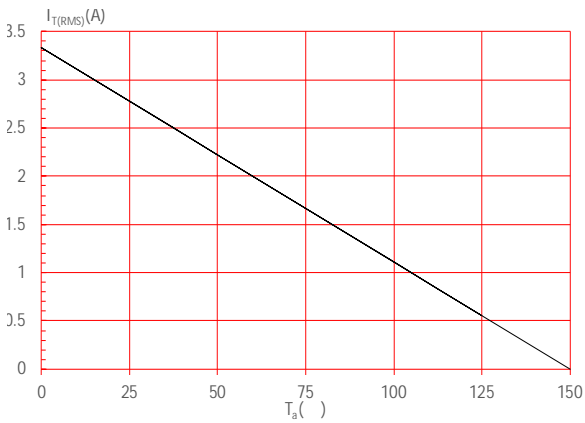

FIG.5: On-state characteristics

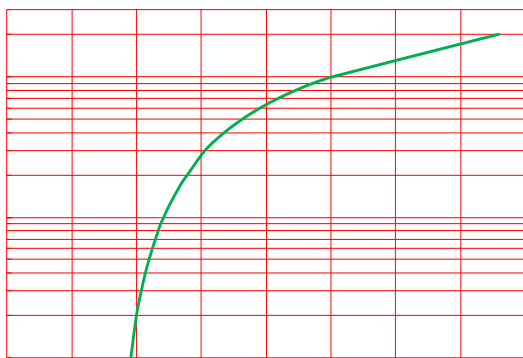

FIG.2: RMS on-state current versus case temperature

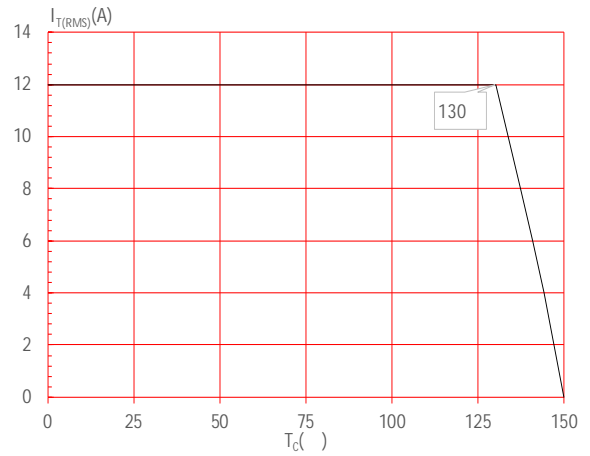

FIG.4: Surge peak on-state current versus number of cycles

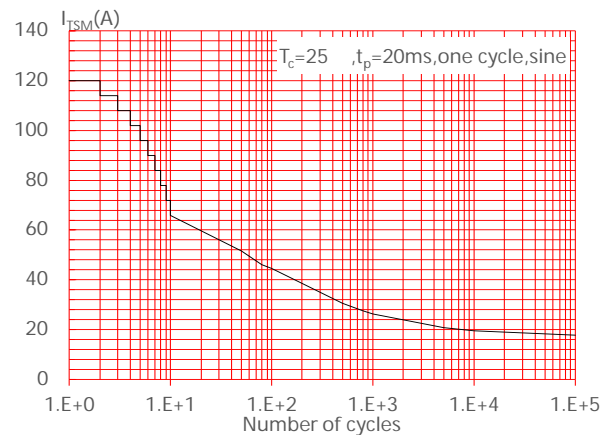

FIG.6: Non-repetitive surge peak on-state current for a sinusoidal pulse with width $t_p < 20ms$, and corresponding value of I^2t ($dI/dt < 100A/\mu s$)

FIG.7: Relative variations of gate trigger current, holding current and latching current versus junction temperature

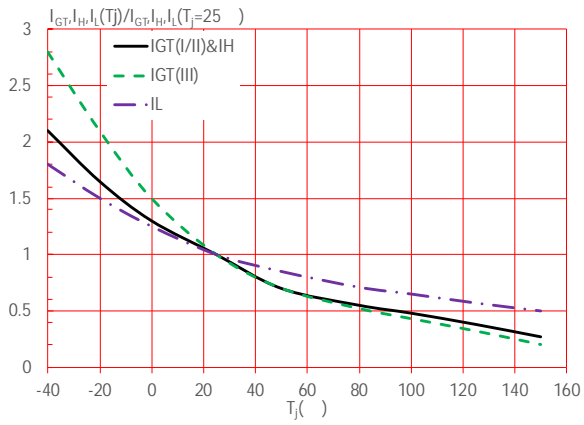
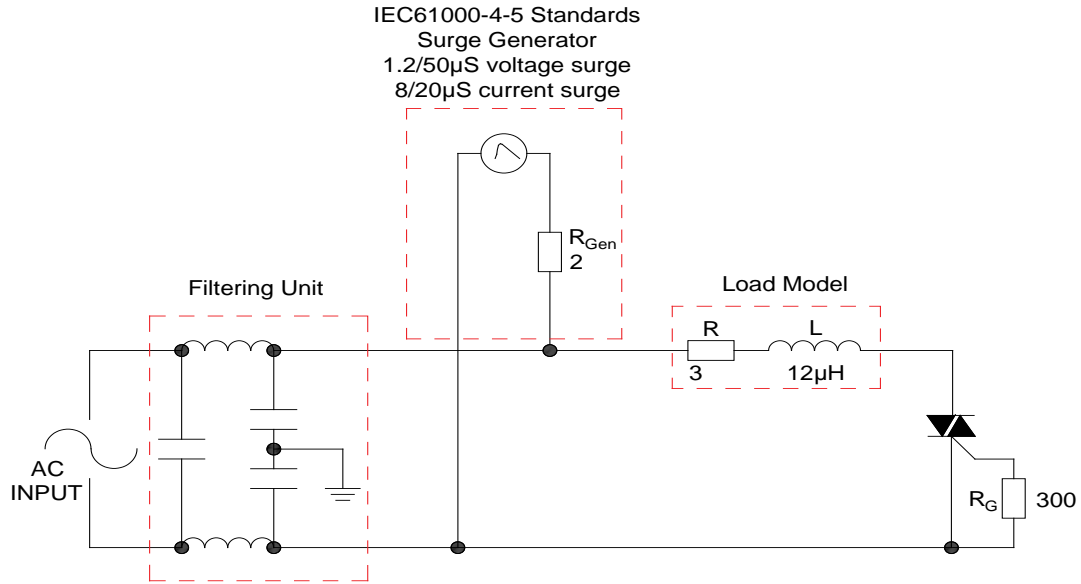
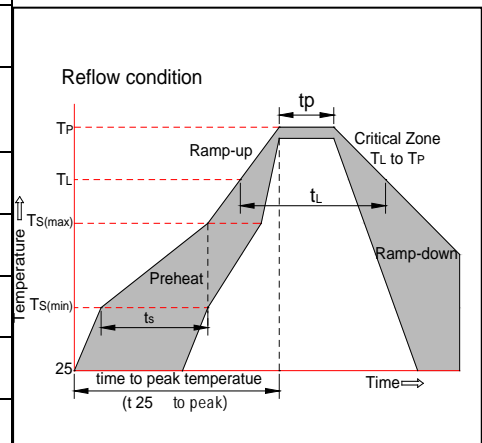

FIG.8 Test circuit for inductive and resistive loads to IEC-61000-4-5 standards



SOLDERING PARAMETERS

Reflow Condition		Pb-Free assembly (see figure at right)
Pre Heat	-Temperature Min (T _{s(min)})	+150
	-Temperature Max(T _{s(max)})	+200
	-Time (Min to Max) (ts)	60-180 secs.
Average ramp up rate (Liquidus Temp (T _L)to peak)		3 /sec. Max
T _{s(max)} to T _L - Ramp-up Rate		3 /sec. Max
Reflow	-Temperature(T _L)(Liquidus)	+217
	-Temperature(t _L)	60-150 secs.
Peak Temp (T _p)		+260(+0/-5)
Time within 5 of actual Peak Temp (t _p)		20-40secs.
Ramp-down Rate		6 /sec. Max
Time 25 to Peak Temp (T _p)		8 min. Max
Do not exceed		+260



ORDERING INFORMATION

Order code	Voltage V_{DRM}/V_{RRM} (V)	IGT(mA)	Package	Base qty. (pcs)	Delivery mode
		- -			
T1250H-8E	800	50	TO-263	50	Tube
T1250H-8E-TR				800	Tape & Reel

Document Revision History

Date	Revision	Changes
Apr.11, 2023	A.1.0	Last updated

DELIVERY MODE



Information furnished in this document is believed to be accurate and reliable. However, Jiangsu JieJie Microelectronics Co., Ltd. assumes no responsibility for the consequences of use without consideration for such information nor use beyond it. Information mentioned in this document is subject to change without notice, apart from that when an agreement is signed, Jiangsu JieJie complies with the agreement.

Products and information provided in this document have no infringement of patents. Jiangsu JieJie assumes no responsibility for any infringement of other rights of third parties which may result from the use of such products and information. This document supersedes and replaces all information previously supplied.

 is a registered trademark of Jiangsu JieJie Microelectronics Co., Ltd.

Copyright © 2023 Jiangsu JieJie Microelectronics Co., Ltd. All rights reserved.