

The T0620H-8C triac is suitable for general purpose AC switching. It can be used as an ON/OFF function in applications such as heating regulation, induction motor starting circuits, for phase control operation in light dimmers, motor speed controllers. Compared to traditional triacs, T0620H-8C provides a very high switching capability up to junction temperatures of 150°C. From T2 terminals to external heatsink. Package TO-220C is RoHS compliant.

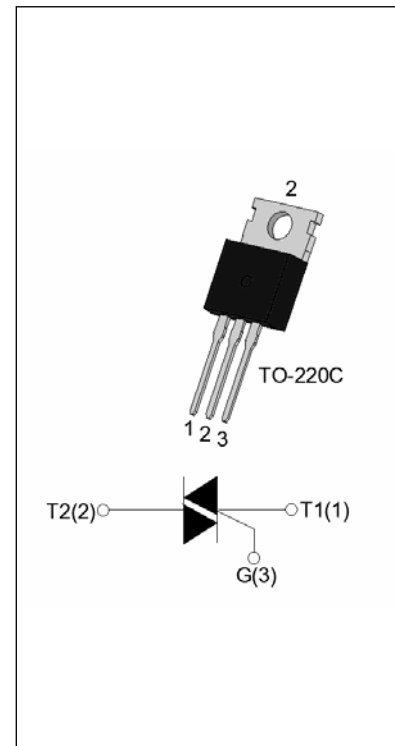

Symbol	Value	Unit
$I_{T(RMS)}$	6	A
V_{DRM}/V_{RRM}	800	V
$I_{GT} / /$	20/20/20	mA

Parameter	Symbol	Value	Unit
Storage junction temperature range	T_{stg}	-40-150	
Operating junction temperature range	T_j	-40-150	
Repetitive peak off-state voltage ($T_j=25^\circ\text{C}$)	V_{DRM}	800	V
Repetitive peak reverse voltage ($T_j=25^\circ\text{C}$)	V_{RRM}	800	V
RMS on-state current ($T_c = 137^\circ\text{C}$)	$I_{T(RMS)}$	6	A
Non repetitive surge peak on-state current (full cycle, $t_p=20\text{ms}$, $T_j=25^\circ\text{C}$)	I_{TSM}	60	A
Non repetitive surge peak on-state current (full cycle, $t_p=16.6\text{ms}$, $T_j=25^\circ\text{C}$)		66	
I^2t value for fusing ($t_p=10\text{ms}$, $T_j=25^\circ\text{C}$)	I^2t	18	A^2s
Critical rate of rise of on-state current ($I_G=2 I_{GT}$, $f=100\text{Hz}$, $T_j=150^\circ\text{C}$)	di/dt	80	$\text{A}/\mu\text{s}$
Peak gate current ($t_p=20\mu\text{s}$, $T_j=150^\circ\text{C}$)	I_{GM}	4	A
Average gate power dissipation ($T_j=150^\circ\text{C}$)	$P_{G(AV)}$	1	W
Peak gate power	P_{GM}	10	W

Peak pulse voltage ($T_j=25$; non-repetitive, off-state; FIG.7)	V_{pp}	3	kV
--	----------	---	----

(T_j=25 unless otherwise specified)

Symbol	Test Condition	Quadrant	Value		Unit
I_{GT}	$V_D=12V R_L=33$	- -	MAX.	20	mA
V_{GT}		- -	MAX.	1	V
V_{GD}	$V_D=V_{DRM} T_j=150$ $R_L=3.3K$	- -	MIN.	0.2	V
I_L	$I_G=1.2I_{GT}$	-	MAX.	40	mA
				55	
I_H	$I_T=100mA$		MAX.	30	mA
dV/dt	$V_D=540V$ Gate Open $T_j=150$		MIN.	800	V/ μs
(dI/dt) _c	(dV/dt) _c =20V/ μs , $T_j=150$		MIN.	2	A/ms
t_{on}	$I_G=40mA I_A=200mA I_R=20mA$ $T_j=25$		TYP.	3	μs
t_{off}				30	

Symbol	Parameter		Value(MAX.)	Unit
V_{TM}	$I_{TM}=8.5A t_p=380\mu s$	$T_j=25$	1.4	V
V_{TO}	Threshold voltage	$T_j=150$	0.8	V
R_D	Dynamic resistance	$T_j=150$	63	m
I_{DRM}	$V_D=V_{DRM} V_R=V_{RRM}$	$T_j=25$	5	μA
I_{RRM}		$T_j=150$	1	mA

Symbol	Parameter	Value	Unit
$R_{th(j-c)}$	junction to case (AC)	1.7	/W
$R_{th(j-a)}$	junction to ambient (AC)	60	/W

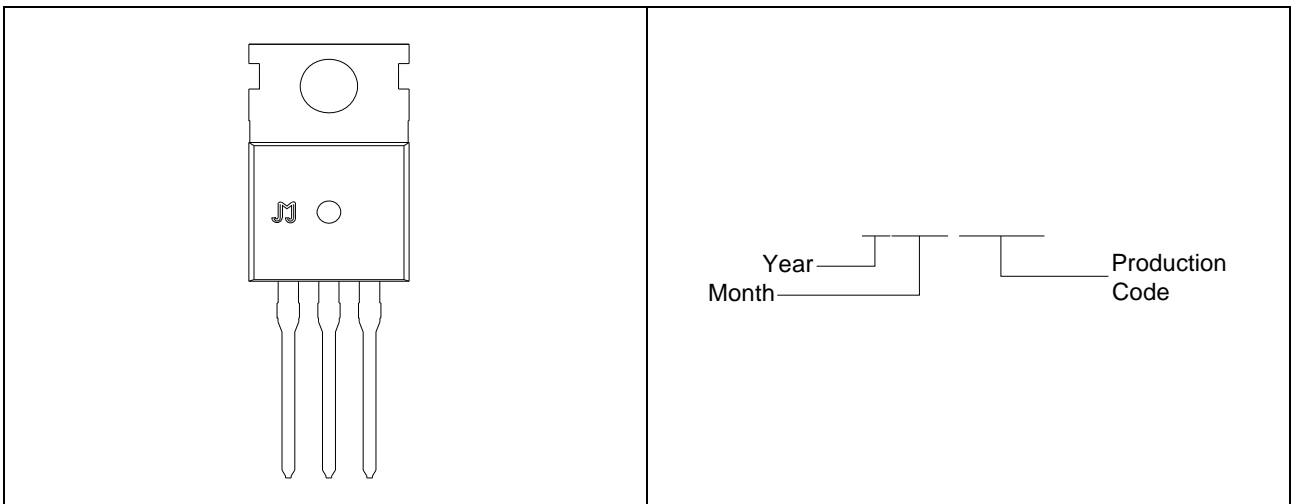
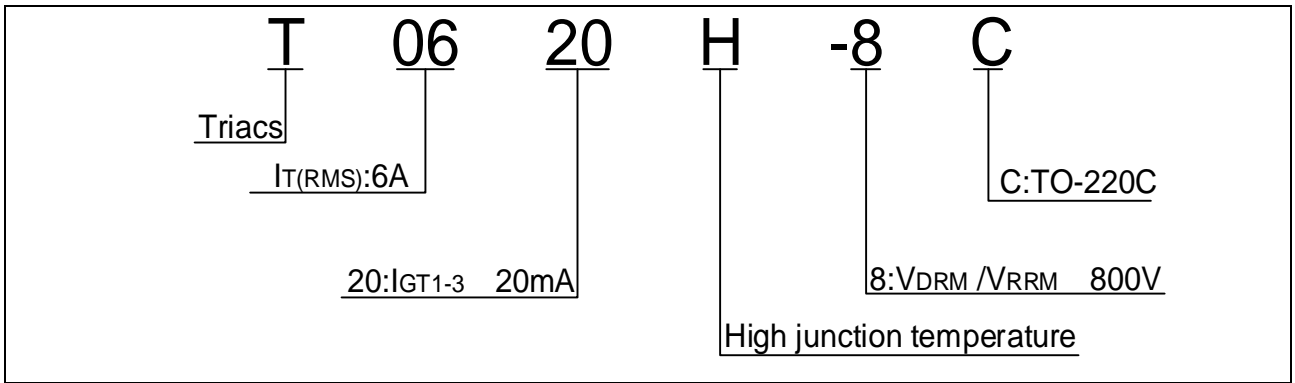

FIG.1 Maximum power dissipation versus RMS on-state current

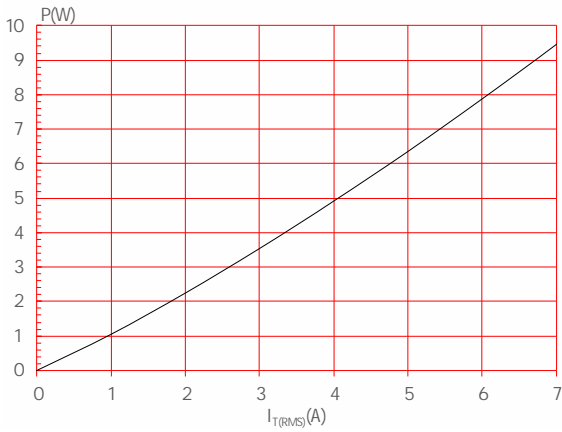

FIG.2: RMS on-state current versus case temperature

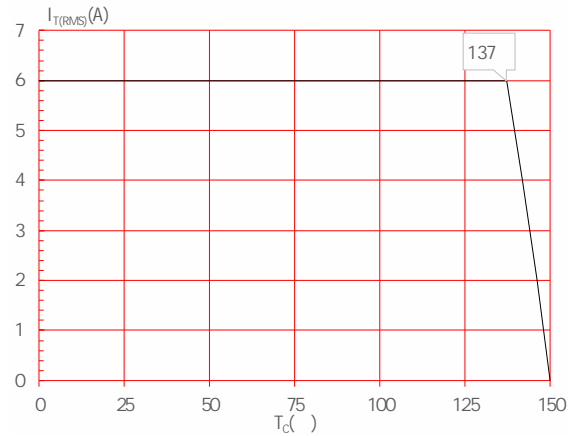

FIG.3: Surge peak on-state current versus number of cycles

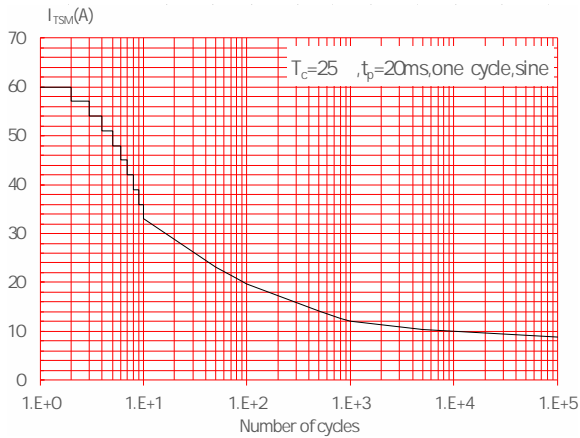

FIG.5: Non-repetitive surge peak on-state current for a sinusoidal pulse with width $t_p < 20\text{ms}$, and corresponding value of I^2t ($di/dt < 80\text{A}/\mu\text{s}$)

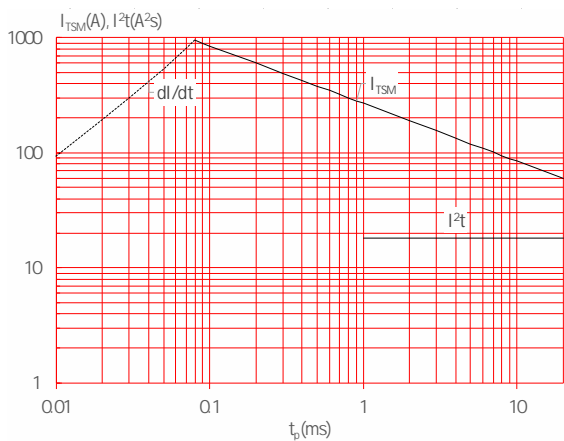

FIG.4: On-state characteristics

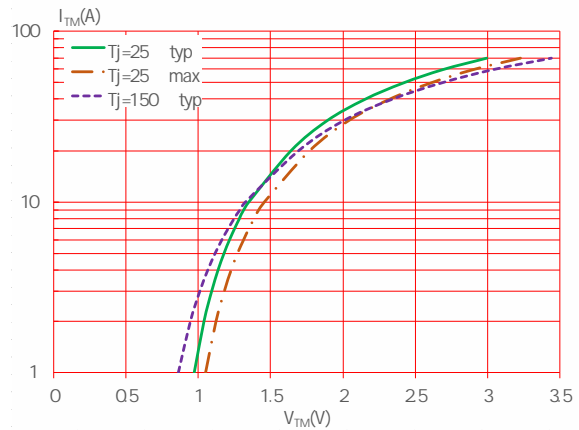

FIG.6: Relative variations of gate trigger current, holding current and latching current versus junction temperature

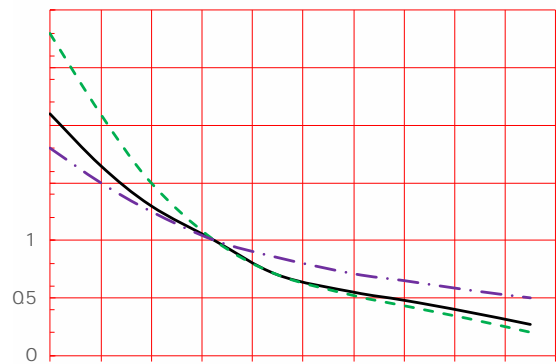
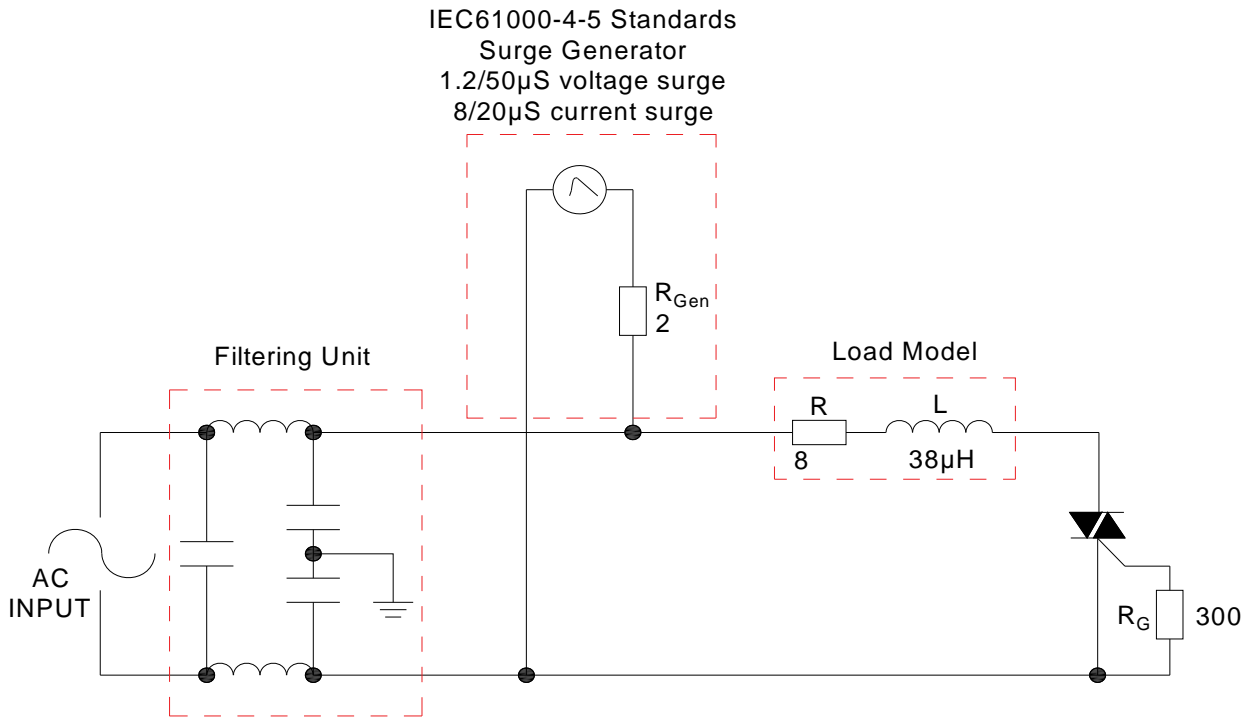

FIG.7 Test circuit for inductive and resistive loads to IEC-61000-4-5 standards



Refer to Instructions for installation of plastic-sealed in-line power devices released by JieJie

Order code	Voltage V_{DRM}/V_{RRM} (V)	IGT(mA)	Package	Base qty. (pcs)	Delivery mode
		- -			
T0620H-8C	800	20	TO-220C	50	Tube

Document Revision History

Date	Revision	Changes
Apr.10, 2023	A.1.0	Last updated

Information furnished in this document is believed to be accurate and reliable. However, Jiangsu JieJie Microelectronics Co., Ltd. assumes no responsibility for the consequences of use without consideration for such information nor use beyond it. Information mentioned in this document is subject to change without notice, apart from that when an agreement is signed, Jiangsu JieJie complies with the agreement.

Products and information provided in this document have no infringement of patents. Jiangsu JieJie assumes no responsibility for any infringement of other rights of third parties which may result from the use of such products and information. This document supersedes and replaces all information previously supplied.

 is a registered trademark of Jiangsu JieJie Microelectronics Co., Ltd.

Copyright ©2023 Jiangsu JieJie Microelectronics Co., Ltd. Printed All rights reserved.