



--	--	--

Parameter	Symbol	Value	Unit
			°C
			°C
			°C
			°C
\leq			°C
			°C
			°C
			°C
×			°C
			°C
			°C
			°C

°C			
----	--	--	--

°C

Symbol	Test Condition	Quadrant	Value	Unit
		I II III		
		I II III		
	°C	I II III		
		I III		
		II		
		°C		
		°C		
	°C			

Symbol	Parameter	Value(MAX.)	Unit
		°C	
		°C	
		°C	
		°C	
		°C	

Symbol	Parameter	Value	Unit
			°C
			°C

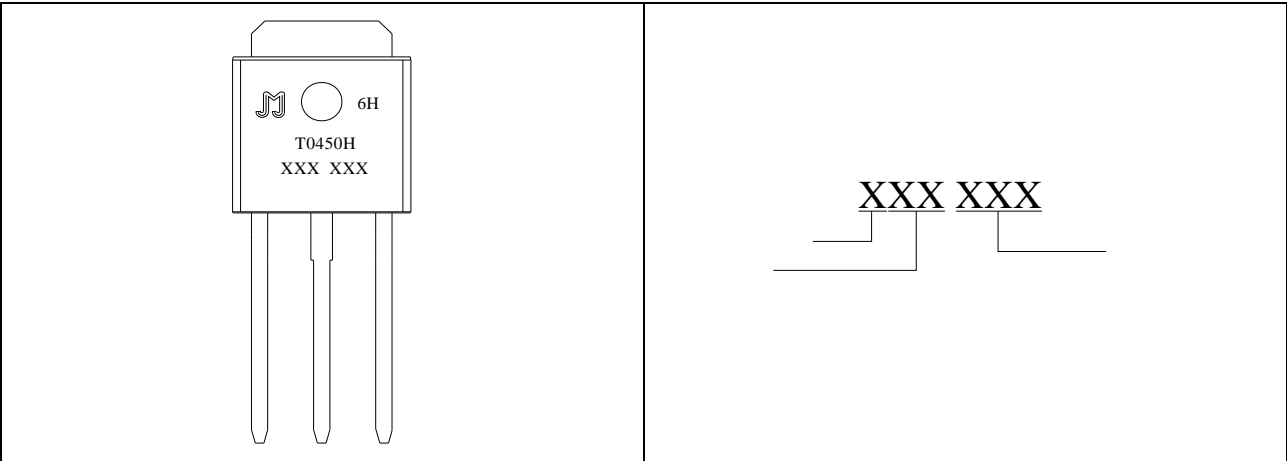
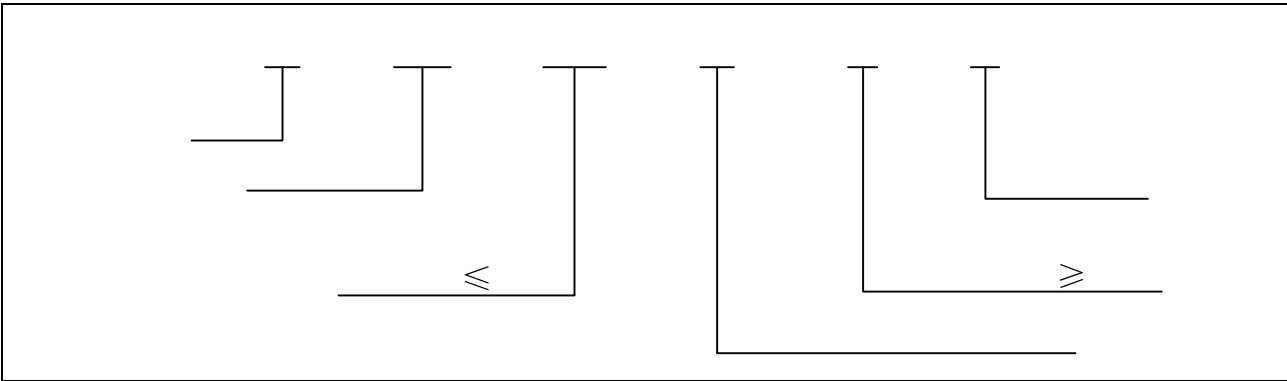

FIG.1

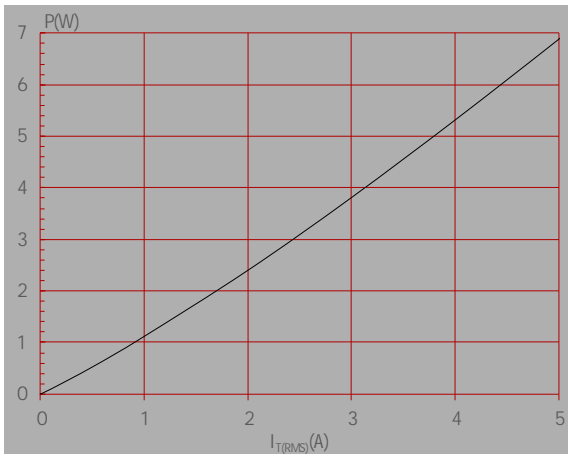

FIG.3:

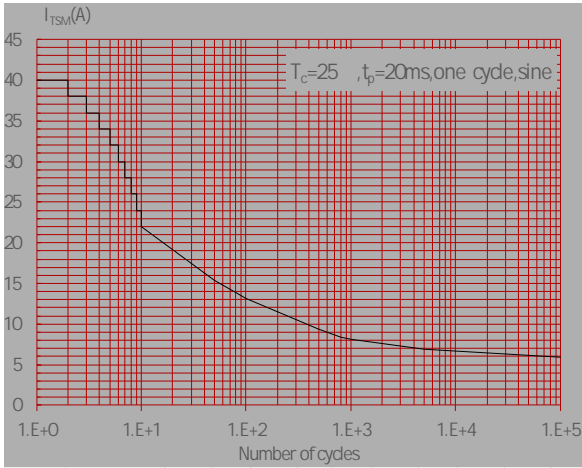

FIG.5:

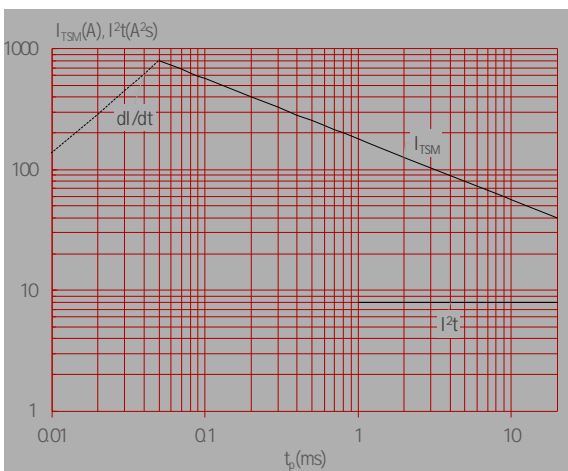

FIG.2:

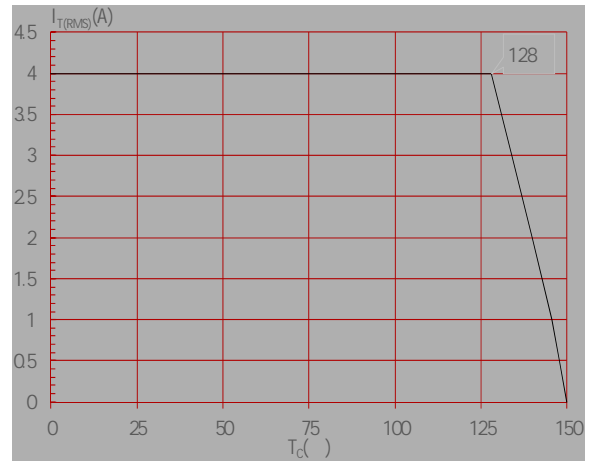

FIG.4:

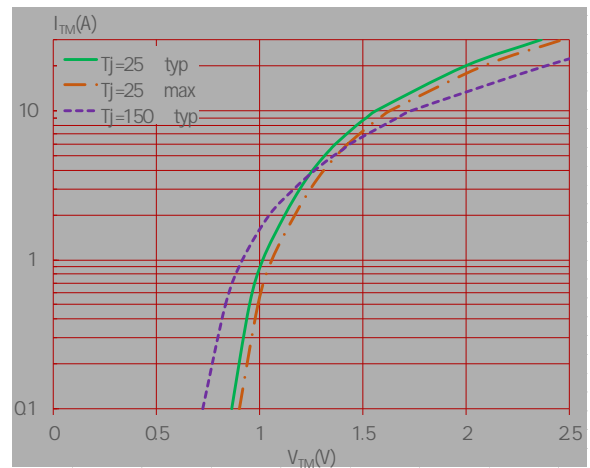
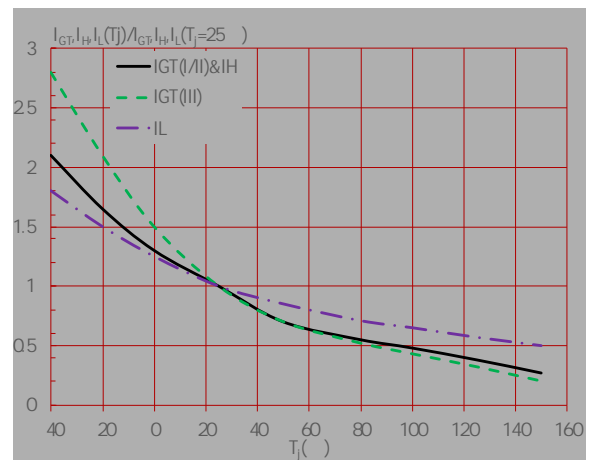
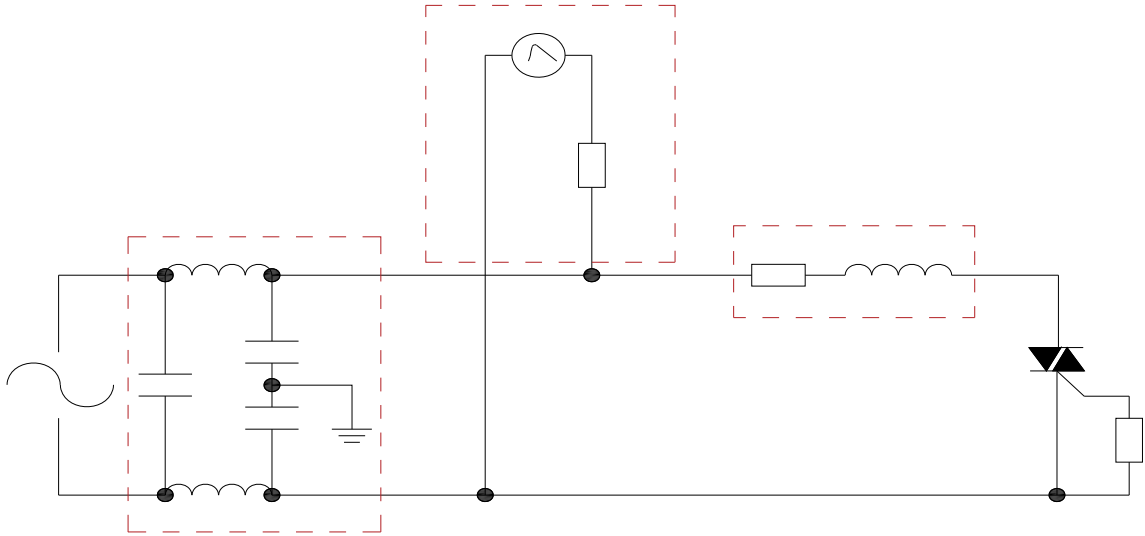

FIG.6:



:



《

》

Order code	Voltage V _{DRM} /V _{RRM} (V)	IGT(mA)	Package	Base qty. (pcs)	Delivery mode
		- -			
T0450H-6H	600	50	TO-251	80	Tube

Document Revision History

Document Revision History		

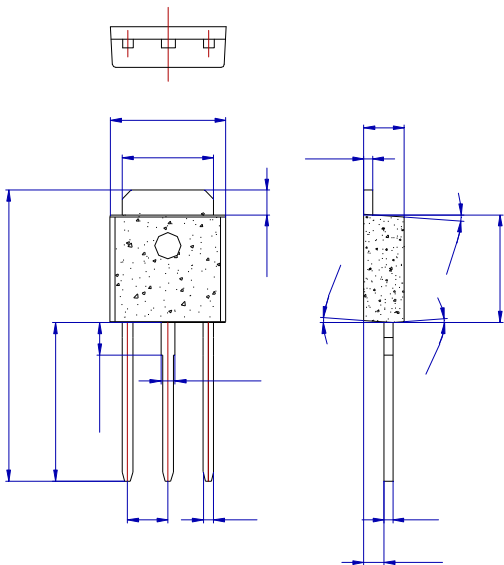

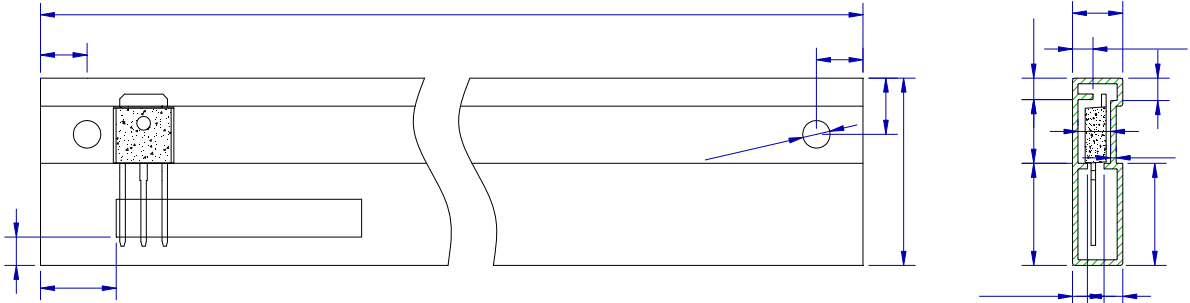

PACKAGE	OUTLINE	TUBE (PCS)	INNER BOX (PCS)	PER CARTON

