



T0420H-8E 4A TRIAC

Rev.A.1.0

DESCRIPTION:

The T0420H-8E triac is suitable for general purpose AC switching. It can be used as an ON/OFF function in applications such as heating regulation, induction motor starting circuits, for phase control operation in light dimmers, motor speed controllers. Compared to traditional triacs, T0420H-8E provides a very high switching capability up to junction temperatures of 150°C. Package TO-263 is RoHS compliant.

MAIN FEATURES

ABSOLUTE MAXIMUM RATINGS

Parameter	Symbol	Value	Unit
Storage junction temperature range	T	T	

Peak pulse voltage ($T_j=25$; non-repetitive, off-state; FIG.8)	V_{pp}	4	kV
--	----------	---	----

ELECTRICAL CHARACTERISTICS ($T_j=25$ unless otherwise specified)

Symbol	Test Condition	Quadrant	Value		Unit
I_{GT}	$V_D=12V$ $R_L=33$	- -	MAX.	20	mA
V_{GT}		- -	MAX.	1	V
V_{GD}	$V_D=V_{DRM}$ $T_j=150$ $R_L=3.3K$	- -	MIN.	0.2	V
I_L	$I_G=1.2I_{GT}$	-	MAX.	30	mA
				40	
I_H	$I_T=100mA$		MAX.	25	mA
dV/dt	$V_D=540V$ Gate Open $T_j=150$		MIN.	800	V/ μs
$(dI/dt)_c$	$(dV/dt)_c=20V/\mu s$, $T_j=150$		MIN.	5	A/ms
t_{on}	$I_G=40mA$ $I_A=200mA$ $I_R=20mA$ $T_j=25$		TYP.	3	μs
t_{off}				30	

STATIC CHARACTERISTICS

Symbol	Parameter		Value(MAX.)	Unit
V_{TM}	$I_{TM}=5.5A$ $t_p=380\mu s$	$T_j=25$	1.4	V
V_{TO}	Threshold voltage	$T_j=150$	0.6	V
R_D	Dynamic resistance	$T_j=150$	129	m
I_{DRM}	$V_D=V_{DRM}$ $V_R=V_{RRM}$	$T_j=25$		

ORDERING INFORMATION

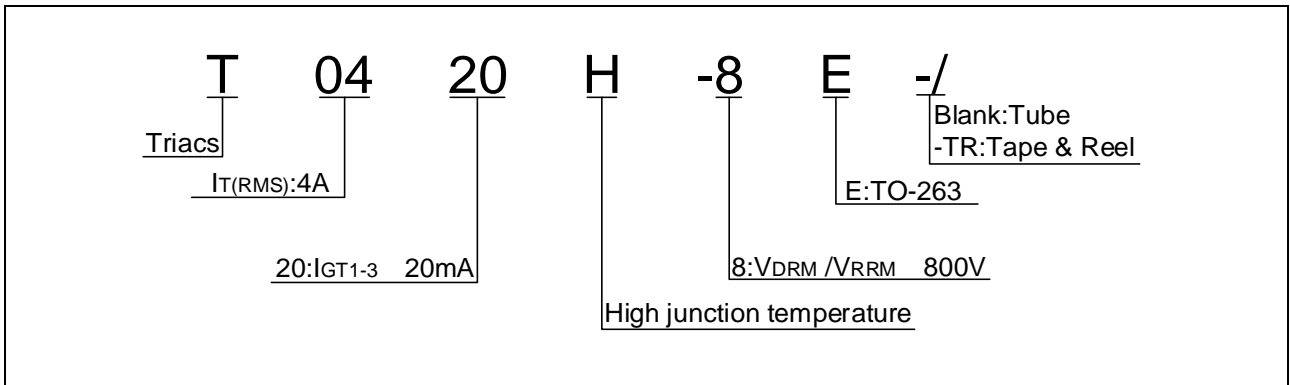

MARKING

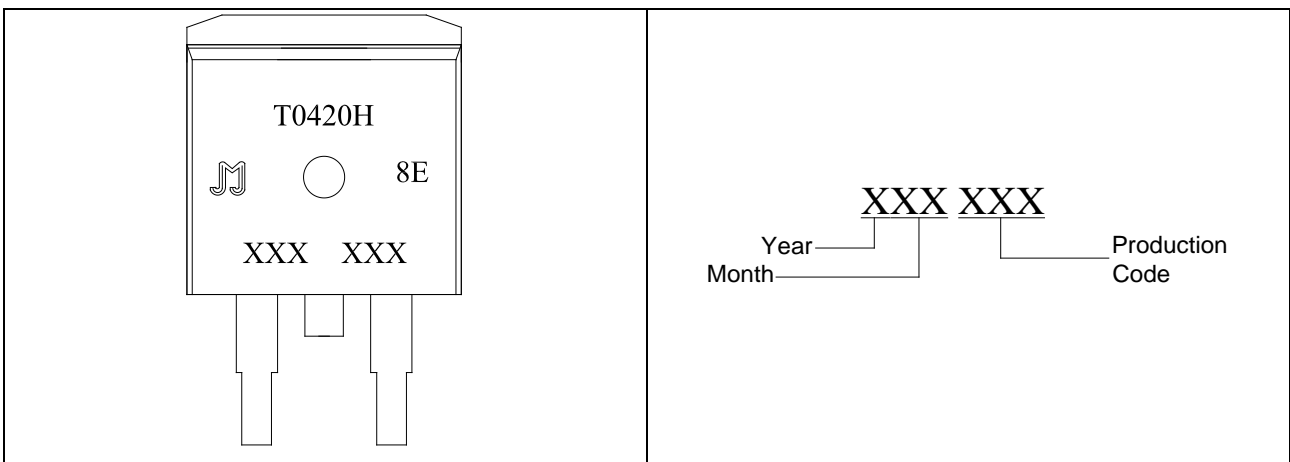

FIG.1 Maximum power dissipation versus RMS on-state current

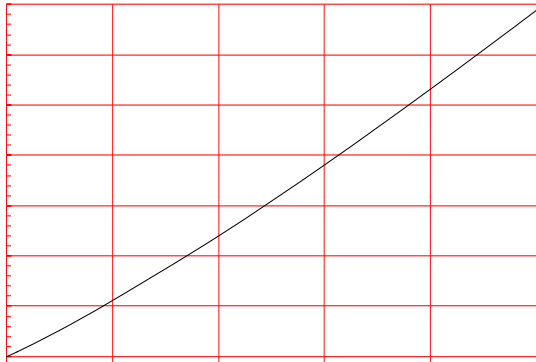

FIG.2: RMS on-state current versus case temperature

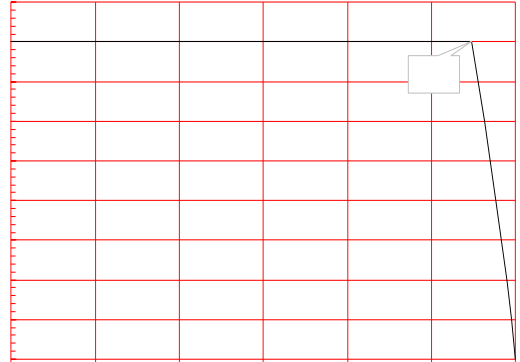

FIG.3: RMS on-state current versus ambient temperature (printed circuit board FR4,copper thickness:35μm)(full cycle)

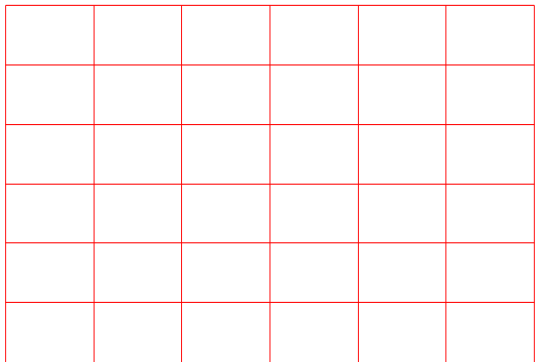

FIG.4: Surge peak on-state current versus number of cycles1

FIG.7: Relative variations of gate trigger current, holding current and latching current versus junction temperature

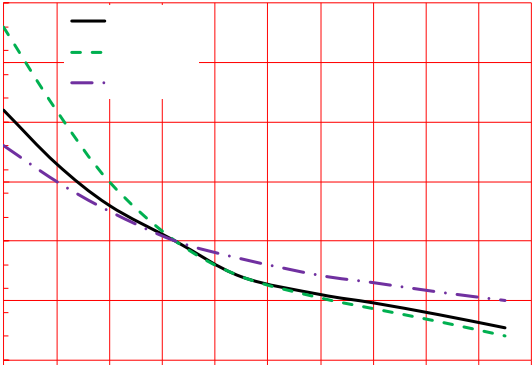
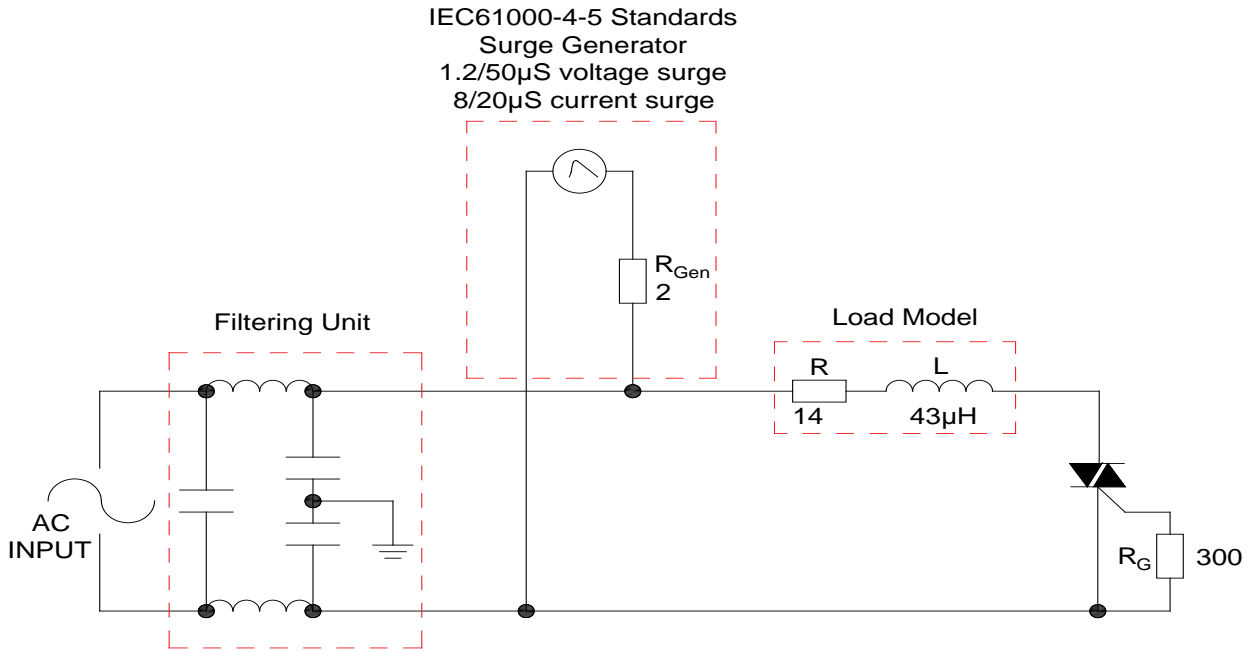

FIG.8 Test circuit for inductive and resistive loads to IEC-61000-4-5 standards



SOLDERING PARAMETERS

Reflow Condition	Pb-Free assembly (see figure at right)
------------------	---

Pre
Heat

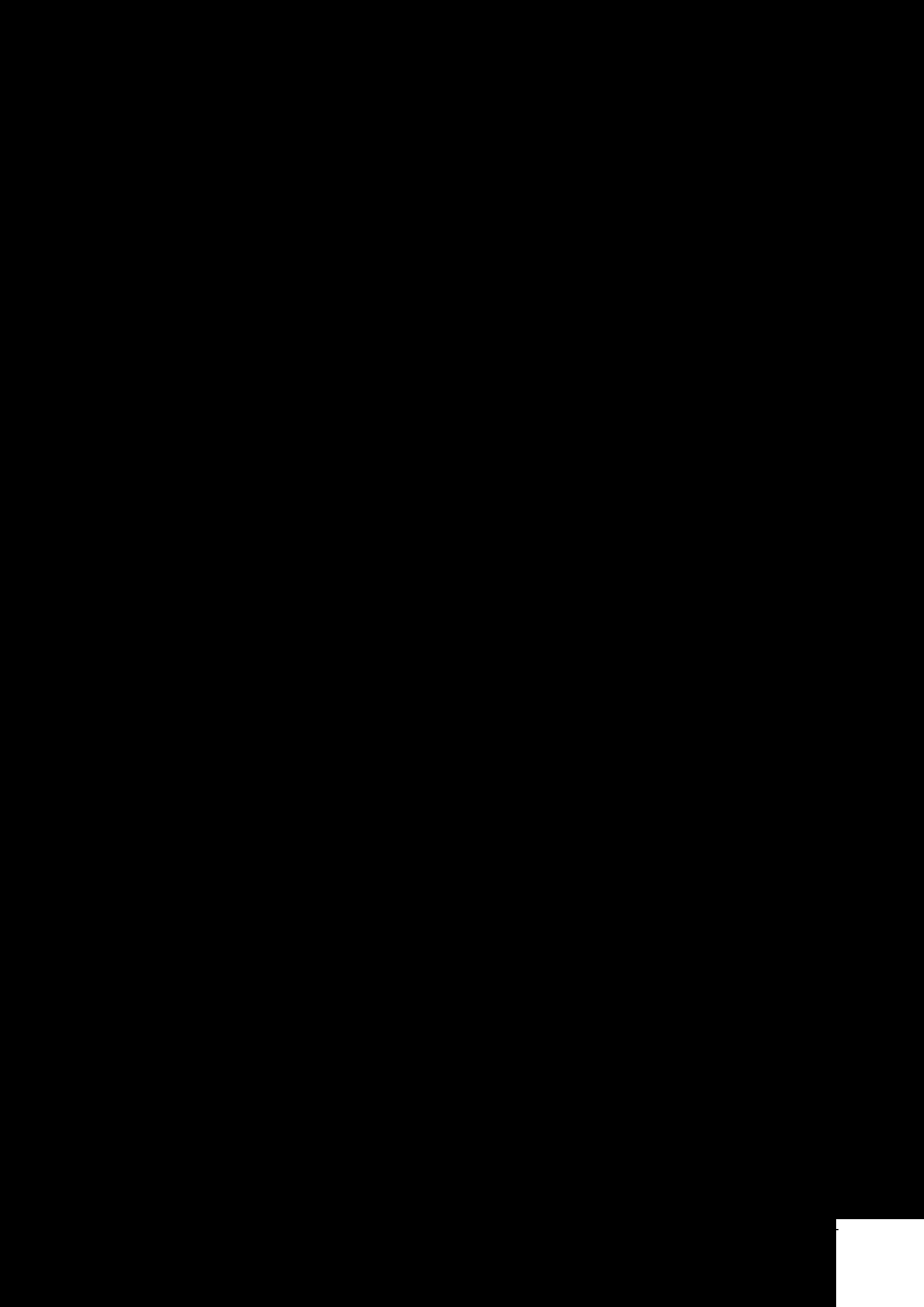

PACKAGE MECHANICAL DATA F

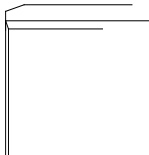

Ref.	Dimensions					
	Millimeters			Inches		
	Min.	Typ.	Max.	Min.	Typ.	Max.
A	9.90		10.20	0.390		0.402
B	14.70		15.80	0.579		0.622
C	9.40		9.60	0.37		0.378
D	2.40			0.094		
E	1.20		1.50	0.047		0.059
F	0.75		0.85	0.029		0.033
G			1.50			
H	4.40		4.70	0.173		0.185
J	2.30		2.70	0.091		0.106
K	0.38		0.55	0.015		0.022
L	0		0.25			
M	1.25		1.35			

DELIVERY MODE

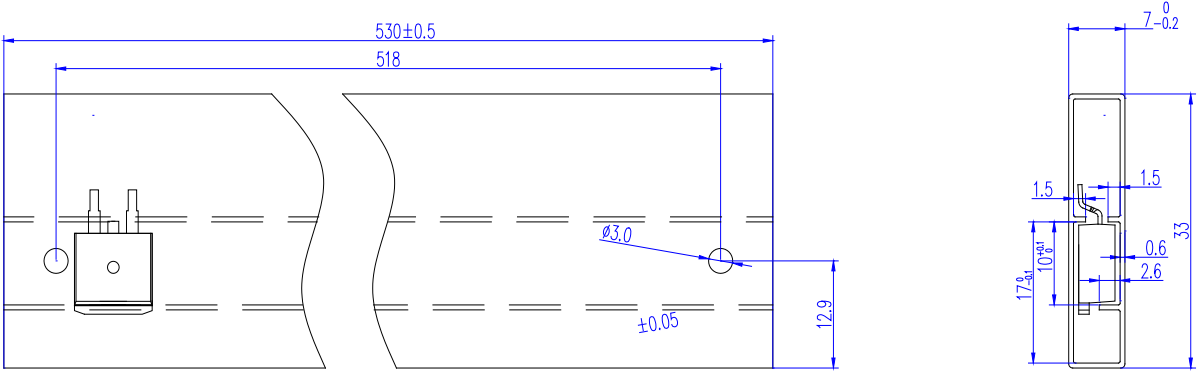

PACKAGE	OUTLINE	
---------	---------	--

Information furnished in this document is believed to be accurate and reliable. However, Jiangsu JieJie Microelectronics Co., Ltd. assumes no responsibility for the consequences of use without consideration for such information nor use beyond it. Information mentioned in this document is subject to change without notice, apart from that when an agreement is signed, Jiangsu JieJie complies with the agreement.

Products and information provided in this document have no infringement of patents. Jiangsu JieJie assumes no responsibility for any infringement of other rights of third parties which may result from the use of such products and information. This document supersedes and replaces all information previously supplied.

 is a registered trademark of Jiangsu JieJie Microelectronics Co., Ltd.

Copyright © 2023 Jiangsu JieJie Microelectronics Co., Ltd. All rights reserved.