



DESCRIPTION:

With high ability to withstand the shock loading of large current, JCT1608K provides high dV/dt rate with strong resistance to electromagnetic interference. It is especially recommended for use on hair straightener, motorcycle voltage regulators etc. Package TO-252 is RoHS compliant.

MAIN FEATURES

Symbol	Value	Unit
$I_{T(RMS)}$	8	A
V_{DRM}/V_{RRM}	1600	V
I_{GT}	15	mA

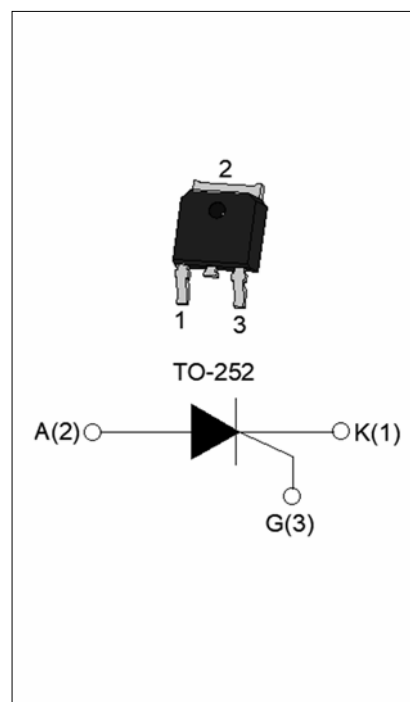

ABSOLUTE MAXIMUM RATINGS

Parameter	Symbol	Value	Unit
Storage junction temperature range	T_{stg}	-40-150	
Operating junction temperature range	T_j	-40-125	
Repetitive peak off-state voltage ($T_j=25^\circ\text{C}$)	V_{DRM}	1600	V
Repetitive peak reverse voltage ($T_j=25^\circ\text{C}$)	V_{RRM}	1600	V
Average on-state current ($T_c = 98^\circ\text{C}$)	$I_{T(AV)}$	5	A
RMS on-state current ($T_c = 98^\circ\text{C}$)	$I_{T(RMS)}$	8	A
Non repetitive surge peak on-state current ($t_p=10\text{ms}, T_j=25^\circ\text{C}$)	I_{TSM}	80	A
Non repetitive surge peak on-state current ($t_p=8.3\text{ms}, T_j=25^\circ\text{C}$)		88	
I^2t value for fusing ($t_p=10\text{ms}, T_j=25^\circ\text{C}$)	I^2t	32	A^2s
Critical rate of rise of on-state current ($I_G=2 I_{GT}, f=100\text{Hz}, T_j=125^\circ\text{C}$)	di/dt	100	$\text{A}/\mu\text{s}$
Peak gate current ($t_p=20\mu\text{s}, T_j=125^\circ\text{C}$)	I_{GM}	4	A

Average gate power dissipation ($T_j=125$)	$P_{G(AV)}$	1	W
Peak gate power	P_{GM}	5	W
Peak pulse voltage ($T_j=25$; non-repetitive,off-state;FIG.8)	V_{pp}	1.8	kV

ELECTRICAL CHARACTERISTICS ($T_j=25$ unless otherwise specified)

Symbol	Test Condition	Value			Unit
		MIN.	TYP.	MAX.	
I_{GT}	$V_D=12V R_L=33$	-	-	15	mA
V_{GT}		-	-	1	V
V_{GD}	$V_D=V_{DRM} T_j=125 R_L=3.3K$	0.2	-	-	V
I_L	$I_G=1.2I_{GT}$	-	-	40	mA
I_H	$I_T=500mA$	-	-	30	mA
dV/dt	$V_D=1070V$ Gate Open $T_j=125$	3000	-	-	V/ μs
t_{on}	$I_G=20mA I_A=200mA I_R=20mA$ $T_j=25$	-	3	-	μs
t_{off}		-	40	-	μs

STATIC CHARACTERISTICS

Symbol	Parameter	Value(MAX.)	Unit
V_{TM}	$I_{TM}=16A t_p=380\mu s$	1.6	V
V_{TO}	$T_j=25$		

ORDERING INFORMATION

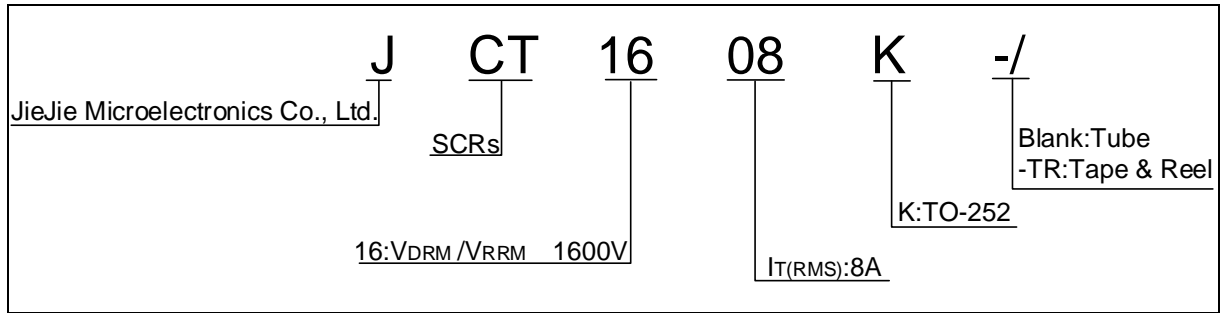

MARKING

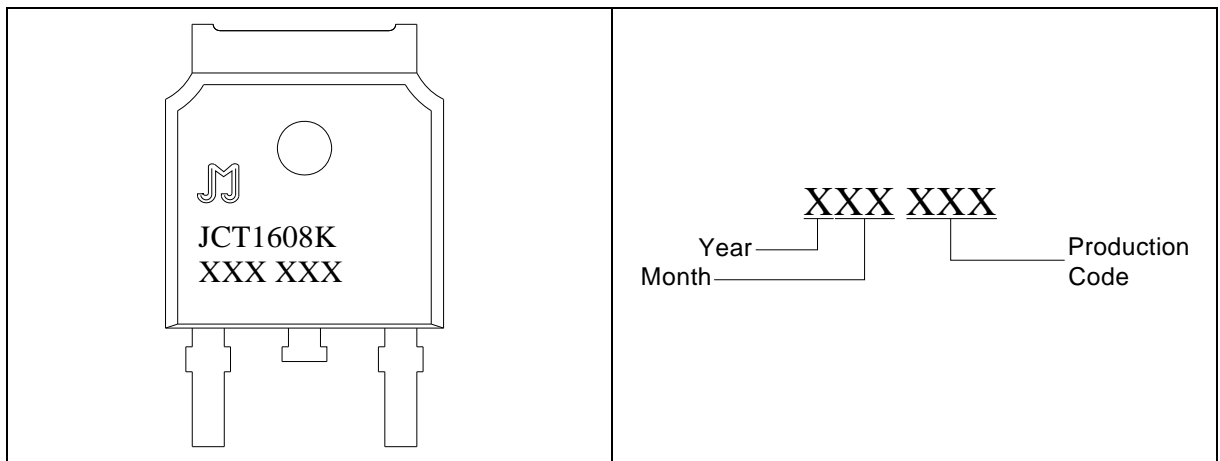

FIG.1 Maximum power dissipation versus RMS on-state current

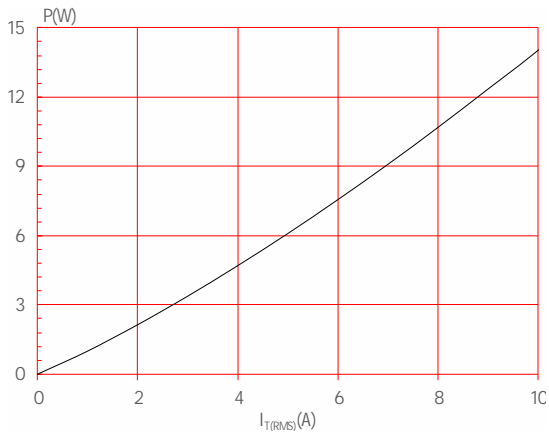

FIG.2: RMS on-state current versus case temperature

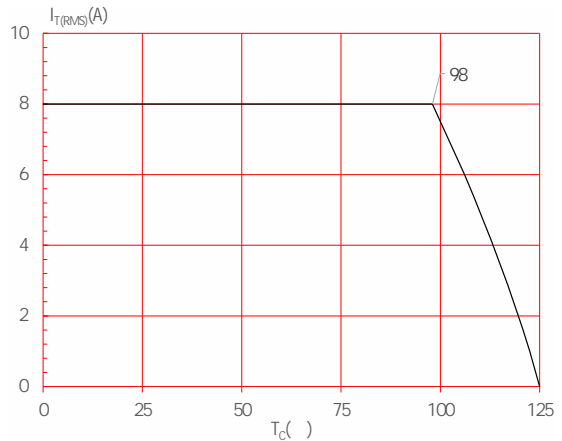

FIG.3: RMS on-state current versus ambient temperature (printed circuit board FR4,copper thickness:35μm)(full cycle)

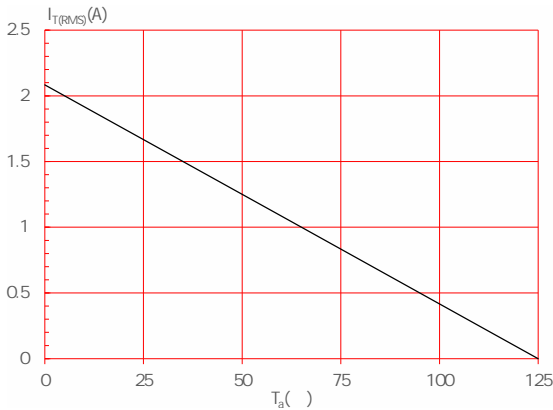

FIG.4: Surge peak on-state current versus number of cycles

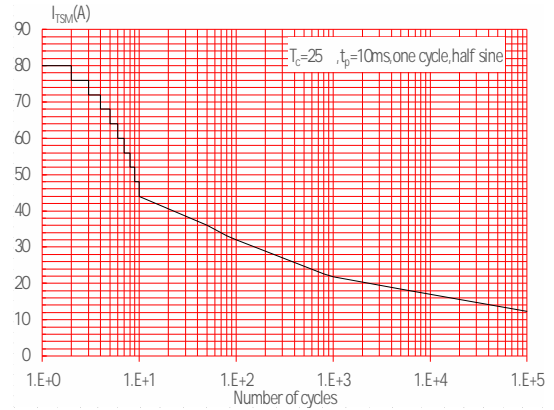

FIG.5: On-state characteristics

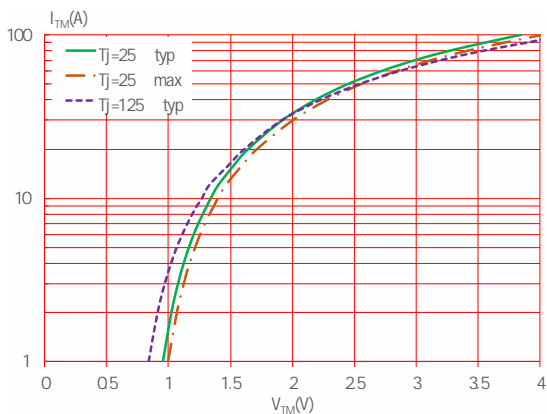

FIG.6: Non-repetitive surge peak on-state current for a sinusoidal pulse with width $t_p < 10\text{ms}$, and corresponding value of I^2t ($di/dt < 100\text{A}/\mu\text{s}$)

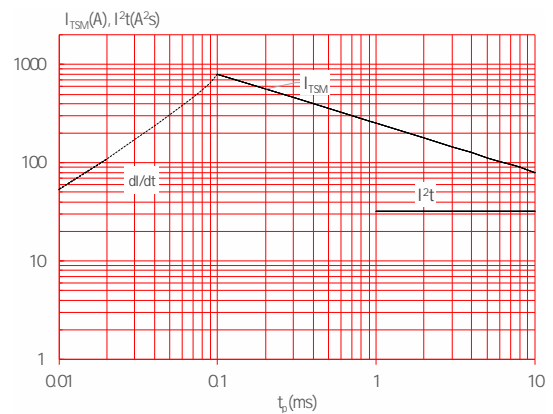

FIG.7: Relative variations of gate trigger current, holding current and latching current versus junction temperature

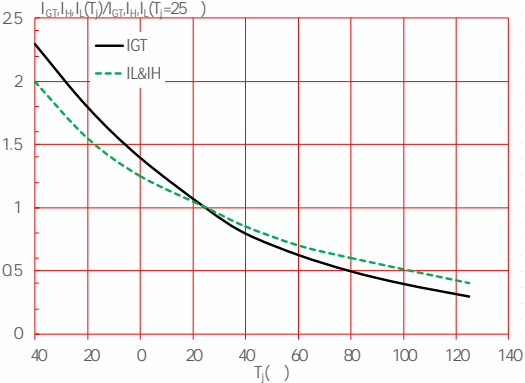
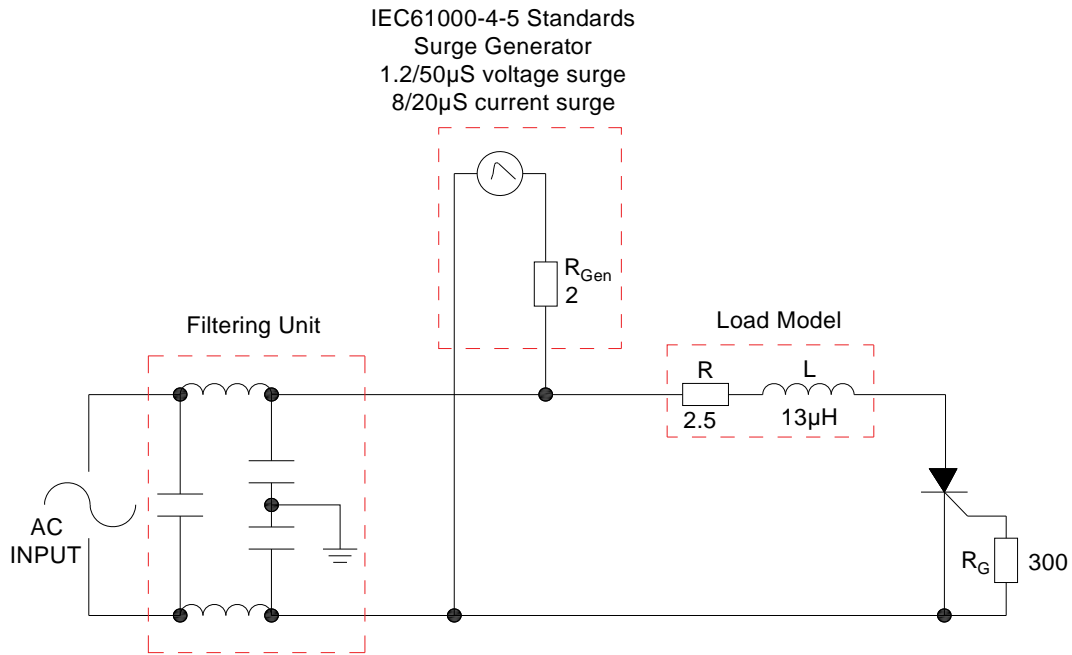
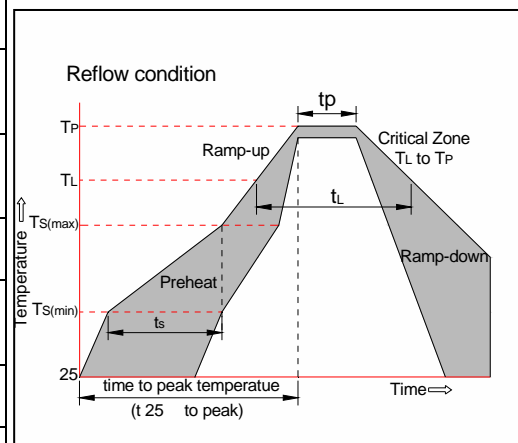

FIG.8 Test circuit for inductive and resistive loads to IEC-61000-4-5 standards.



SOLDERING PARAMETERS

Reflow Condition		Pb-Free assembly (see figure at right)
Pre Heat	-Temperature Min ($T_{s(min)}$)	+150
	-Temperature Max($T_{s(max)}$)	+200
	-Time (Min to Max) (t_s)	60-180 secs.
Average ramp up rate (Liquidus Temp (T_L) to peak)		3 /sec. Max
$T_{s(max)}$ to T_L - Ramp-up Rate		3 /sec. Max
Reflow	-Temperature(T_L) (Liquidus)	+217
	-Temperature(t_L)	60-150 secs.
Peak Temp (T_p)		+260(+0/-5)
Time within 5 of actual Peak Temp (t_p)		20-40secs.
Ramp-down Rate		6 /sec. Max
Time 25 to Peak Temp (T_p)		8 min. Max
Do not exceed		+260



ORDERING INFORMATION

Order code	Voltage V_{DRM}/V_{RRM} (V)	IGT(mA)	Package	Base qty. (pcs)	Delivery mode
JCT1608K	1600	15	TO-252	80	Tube
JCT1608K-TR				2,500	Tape & Reel

Document Revision History

Date	Revision	Changes
Apr.07, 2024	A.1.0	Last update

PACKAGE MECHANICAL DATA

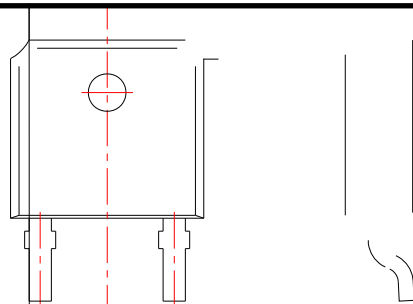

Ref.	Dimensions					
	Millimeters			Inches		
	Min.	Typ.	Max.	Min.	Typ.	Max.
A	2.10		2.50	0.083		0.098
A2	0		0.10	0		0.004
B	0.66		0.86	0.026		0.034
B2	5.18		5.48	0.202		0.216
C	0.40		0.60	0.016		0.024
C2	0.44		0.58	0.017		0.023
D	5.90		6.30	0.232		0.248
D1						
E	6.40		6.80	0.252		0.268
E1	4.63			0.182		
G	4.47		4.67	0.176		0.184
H	9.50		10.70	0.374		0.421
L	0.95		1.30	0.037		0.051
L2	1.35		1.75	0.053		0.069
V1		7°			7°	
V2	0°		6°	0°		6°

DELIVERY MODE

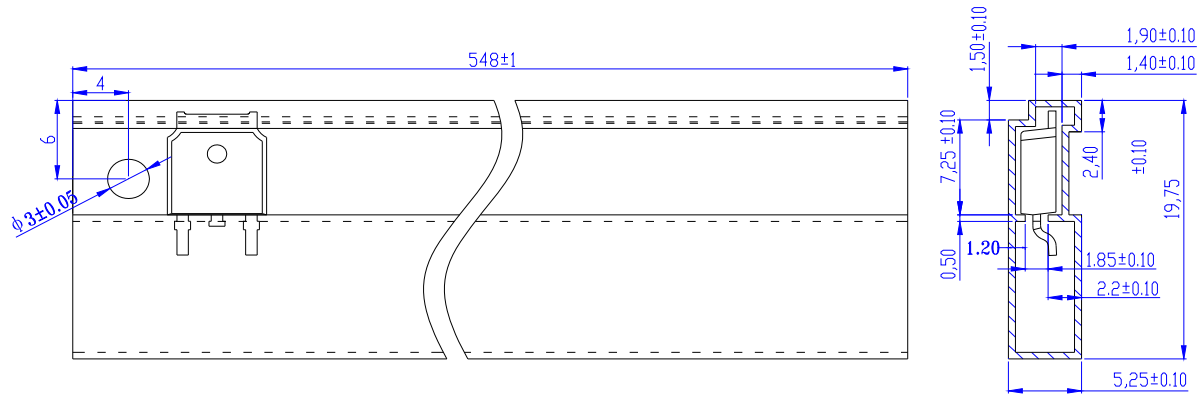

PACKAGE	OUTLINE	TUBE (PCS)	INNER BOX (PCS)	PER CARTON
TO-252	TUBE	80	4,000	20,000

Ref.	Dimensions					
	Millimeters			Inches		
	Min.	Typ.	Max.	Min.	Typ.	Max.
W	15.90	16.00	16.10			
E		1.75	1.85			
F						
D0						
D1						
P0						
P1						
P2						
10P0						
A0						
B0						
K0						
T						
t1						

Information furnished in this document is believed to be accurate and reliable. However, Jiangsu JieJie Microelectronics Co., Ltd. assumes no responsibility for the consequences of use without consideration for such information nor use beyond it. Information mentioned in this document is subject to change without notice, apart from that when an agreement is signed, Jiangsu JieJie complies with the agreement. Products and information provided in this document have no infringement of patents. Jiangsu JieJie assumes no responsibility for any infringement of other rights of third parties which may result from the use of such products and information. This document supersedes and replaces all information previously supplied.

 is a registered trademark of Jiangsu JieJie Microelectronics Co., Ltd. Copyright © 2024 Jiangsu JieJie Microelectronics Co., Ltd. All rights reserved.