

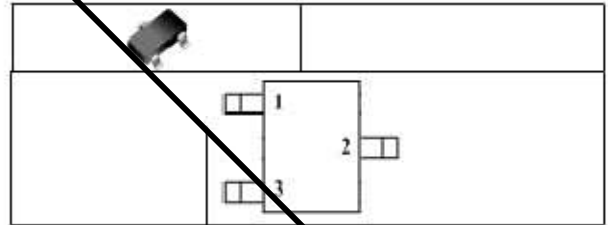

低压差高输出精度线性稳压

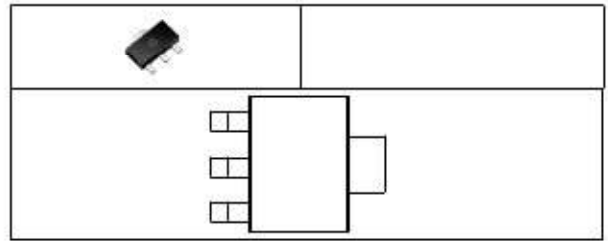







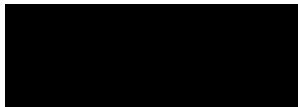

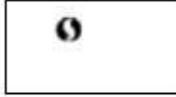

高输出电流：
 输出短路保护
 结温超过 110°C，输出电流降低

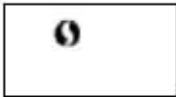
典型应用

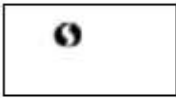

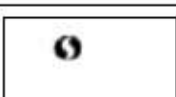
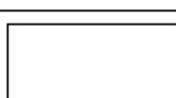
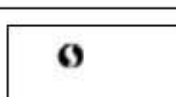

-
-
-

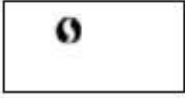

订货信息

产品名	订货信息	封			
JD	JD N				
	JD L	L		编带	盘
					
					
					
					
					
					
					
					
					
					

JD

JD	JD	N	-2L		编带	盘
	JD	L	L		编带	盘
JD	JD	N	-2L		编带	
	JD	L				

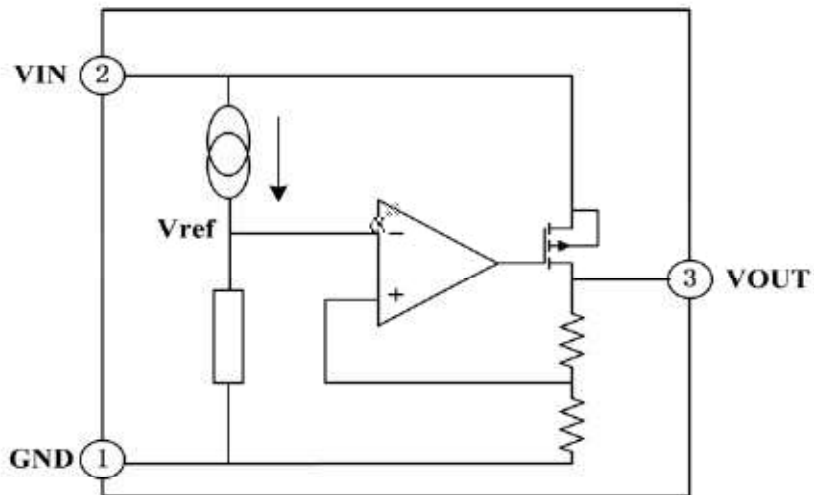

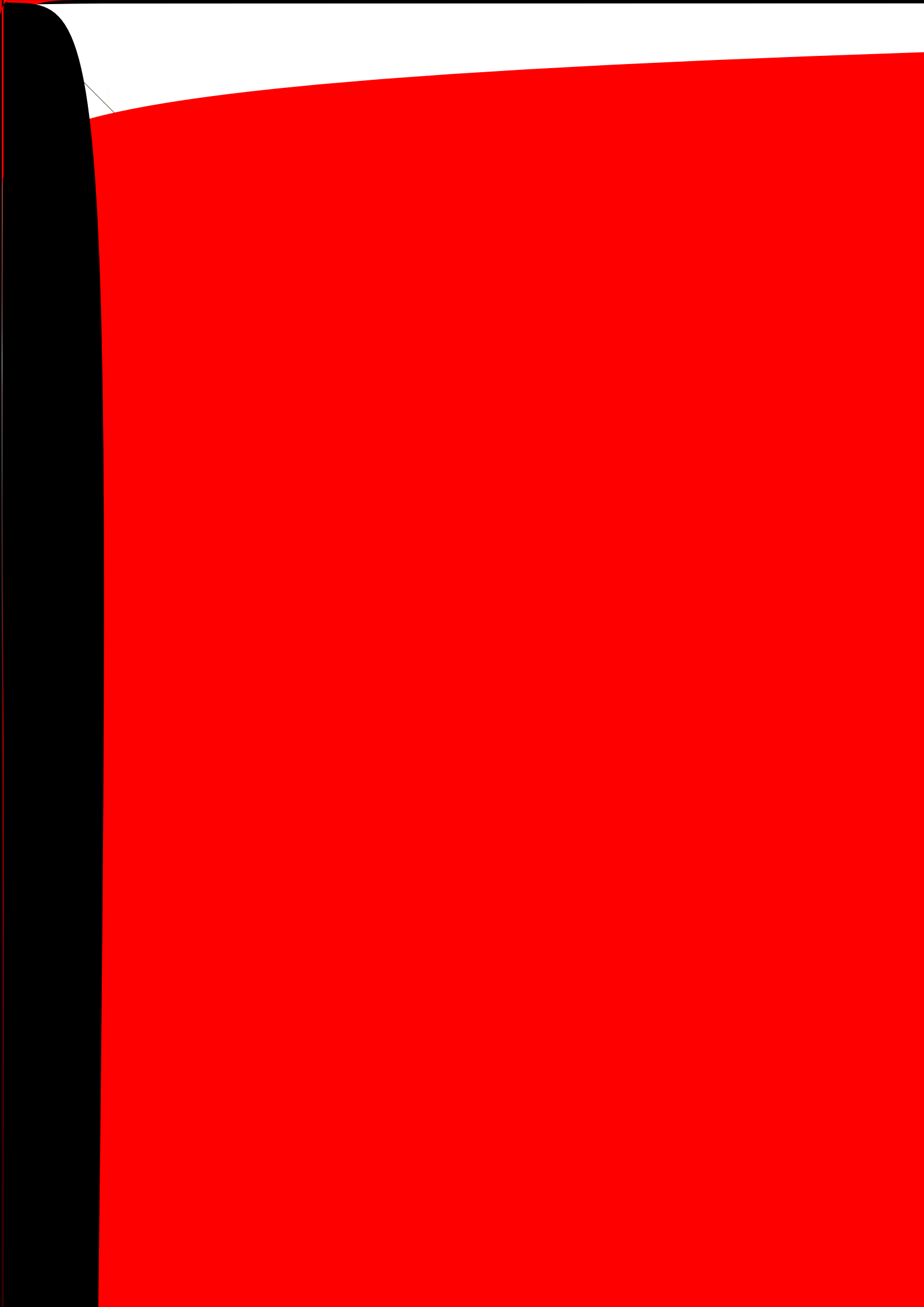



输出型号 JD7140H

参数说明						
输出电压						
输出电流						
负载调整率						
低压差						

输出电压的差值

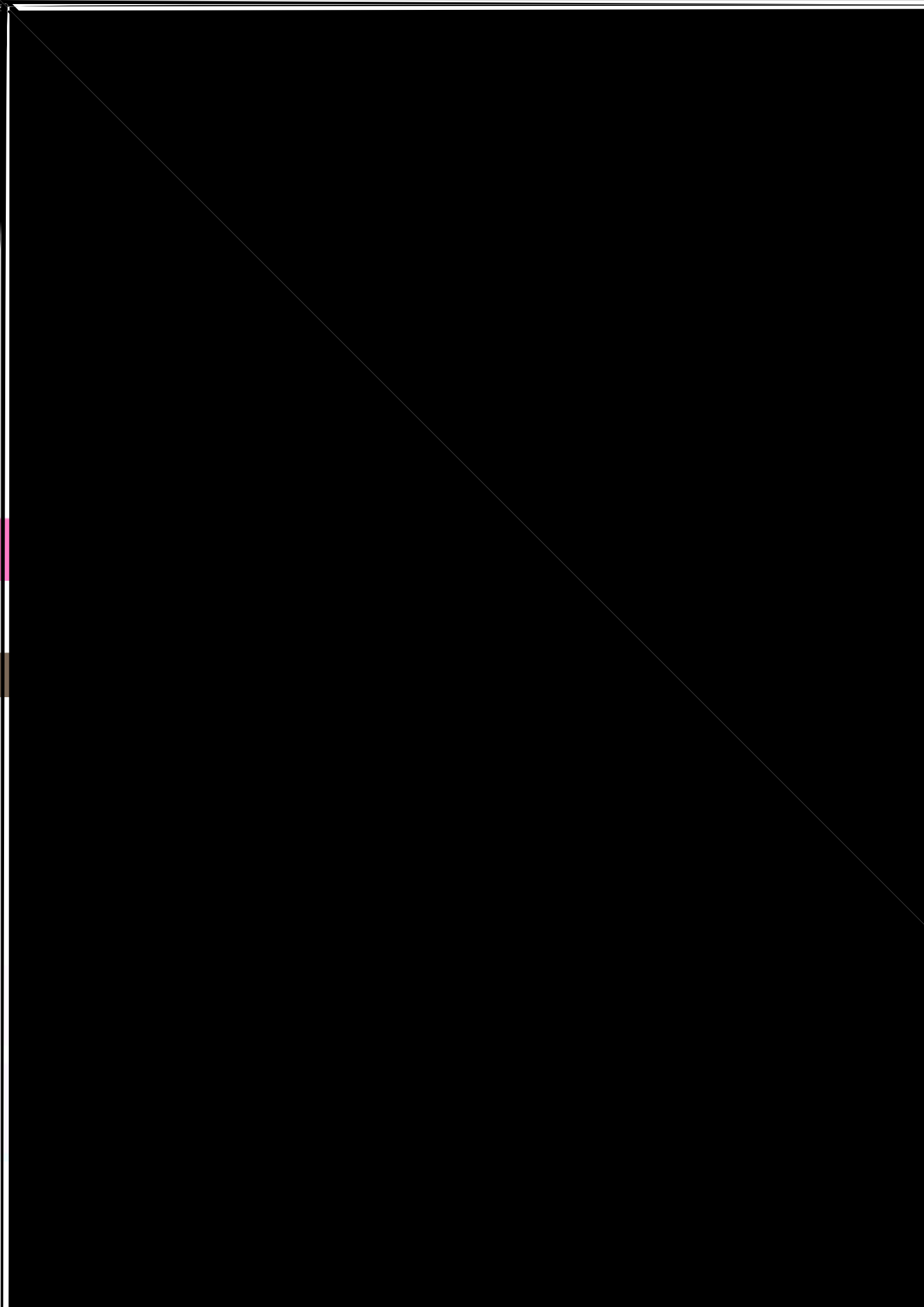



超出封装允许的最大功

